



Historic Bridge Management Plan for the Grand Lake Pontoon Bridge

Recall Number: 033760

Structure Number: 07121953000931

Parish: Cameron

Route: LA 384

Crossing Description: Intracoastal Waterway-
Sweet/Grand Lake



Prepared for

**Louisiana Department of
Transportation and
Development**

Prepared by

**Mead
& Hunt**

www.meadhunt.com

March 2017

THIS PAGE INTENTIONALLY LEFT BLANK

Table of Contents

	Page
Executive Summary	1
1. Introduction	3
2. Location Map	5
3. Historic Data	7
A. Identifying information	7
B. Description of bridge	7
C. History and significance	9
D. Character-defining features	10
4. Engineering Data.....	15
A. Existing conditions	15
(1) Structural observations	15
(2) Non-structural observations	16
(3) Serviceability observations.....	16
B. Sources of information.....	17
5. Recommendations	25
A. Preventative maintenance	25
B. Rehabilitation	26
C. Identification of any anticipated design exceptions	26

Appendices

- A Historic Inventory Form
- B Select Plan Sheets

THIS PAGE INTENTIONALLY LEFT BLANK

Executive Summary

The Grand Lake Pontoon Bridge (Recall No. 033760) is located in Cameron Parish, Louisiana, and is owned by the State of Louisiana. The bridge was completed in 1963. It was determined to be eligible for the National Register of Historic Places (National Register) in 2013. It is significant as a distinctive example of a movable bridge. Its significance is demonstrated by the presence of distinctive engineering and design features of the pontoon swing bridge type, which is characterized by a floating pontoon span, a pivot arm, the two approach apron lift spans, and the lift towers.

The bridge carries two lanes of Louisiana Highway (LA) 384 across the Intracoastal Waterway, providing access between Calcasieu Lake to the west and Sweet Lake and Grand Lake to the east of the bridge. Its total length of approximately 421 feet encompasses approach spans to the west and east, and approach apron lift spans immediately to the west and east of the pontoon swing main span. The swing span is a steel pontoon with interior compartments and bulkheads. The six approach spans on each side of the swing span consist of cast-in-place, reinforced-concrete slabs. The approach apron lift spans each consist of two counterweighted lift towers that raise the steel apron spans vertically to allow clearance for the pontoon to swing into the open position. The operator's house is located on the south side of the east approach spans. The hydraulic equipment is housed in a shed behind the operator's house. The bridge's generator house is located on the shore at the southeast corner of the bridge. A timber fender system provides for a navigation channel through the bridge. The bridge is classified as a complex structure because it contains one pontoon swing span.

The bridge is in good condition overall and appears to adequately serve its purpose of carrying vehicular traffic, with the ability to open and allow water navigation traffic to pass through the bridge. The operation of the bridge is satisfactory, as observed in the opening-closing cycles during the field visit. The major deficiencies are corrosion with section loss to the counterweight guide bars, and paint failure with corrosion and section loss to the four steel counterweights. Traffic gates are located outside the approach spans. The operating equipment is adequately maintained. With proper maintenance and rehabilitation, the Grand Lake Pontoon Bridge can continue to serve in its present capacity for 20 years or longer.

Any work on the bridge should proceed according to recommendations in this Historic Bridge Management Plan (Plan), which adhere to the *Secretary of the Interior's Standards for the Treatment of Historic Properties* (Secretary's Standards), the *Management Plan for Historic Bridges Statewide* (Statewide Historic Bridge Plan), and the *Programmatic Agreement among the Federal Highway Administration, the Louisiana Department of Transportation And Development, the Advisory Council on Historic Preservation, and the Louisiana State Historic Preservation Officer Regarding Management of Historic Bridges in Louisiana* (PA).

THIS PAGE INTENTIONALLY LEFT BLANK

1. Introduction

This Plan, used in conjunction with the Statewide Historic Bridge Plan, provides guidance on the approach to preservation activities for the Grand Lake Pontoon Bridge (Recall No. 033760), identified as a Preservation Priority Bridge. Completion of individual management plans for Preservation Priority Bridges and the Statewide Historic Bridge Plan fulfills terms of the PA, which was executed on September 21, 2015.

The PA provides the basis and procedures for the management of historic bridges in Louisiana and outlines the procedures for the treatment of historic bridges, including Preservation Priority Bridges. In accordance with the PA, an owner seeking state or federal funding for Preservation Priority Bridges will be required by the Louisiana Department of Transportation and Development (LADOTD), in cooperation with the Louisiana State Historic Preservation Office (LASHPO) and the Federal Highway Administration (FHWA), to follow the procedures outlined in this Plan and the Statewide Historic Bridge Plan.

The Statewide Historic Bridge Plan outlines the overall approach to bridge preservation through a discussion of the collaboration of the historian and engineer, guidance on assessing preservation needs, and resources and technical guidance on maintenance and rehabilitation activities that are broadly applicable to historic bridges. A glossary of common engineering and historical terms is included in the Statewide Historic Bridge Plan.

This Plan for the Grand Lake Pontoon Bridge compiles and summarizes the specific historic and engineering information for this Preservation Priority Bridge. It documents the existing use and condition of the bridge, along with assessments of the preservation needs, including cost estimates. Preservation can be accomplished in two manners: preventative maintenance and rehabilitation. Maintenance includes cyclical or condition-based activities that, along with regular structural inspections, are directed toward continued structure serviceability. Rehabilitation activities are near- or long-term steps that need to be taken to preserve and in some cases restore a bridge's structural condition and serviceability. In assessing preservation activities for each Preservation Priority Bridge, a design life of 20 years was considered, which is consistent with the duration of the PA. This Plan provides the bridge owner, and other interested parties, with detailed information related to the historic nature of the bridge and the necessary background to make an informed planning decision. Recommendations within this Plan should be reviewed in 10 years following completion of the Plan to identify any needed updates or revisions.

Existing bridge data sources typically available for Louisiana bridges were gathered for this Plan, and field investigation confirmed the general structural condition and character-defining features of the subject bridge. These sources include:

- The current LADOTD Bridge Inspection Report, and any other similar inspection reports
- Original bridge construction plans, any rehabilitation plans, and record as-built plans, as available
- Existing historical and documentary material related to the historic bridges

Recommendations within this Plan are consistent with the Secretary's Standards. The Secretary's Standards are basic principles created to help preserve the distinct character of a historic property and its site, while allowing for reasonable change to meet new engineering standards and codes. The Secretary's Standards recommend repairing, rather than replacing, deteriorated features whenever possible. A version of the Secretary's Standards that is specific to historic bridges is included in the Statewide Historic Bridge Plan. Following these standards is a requirement of the PA.

A bridge historian and bridge engineer from Mead & Hunt, Inc. (Mead & Hunt) jointly prepared this Plan under contract to the LADOTD. The LADOTD, FHWA, and LASHPO reviewed and provided input into the final Plan.

2. Location Map

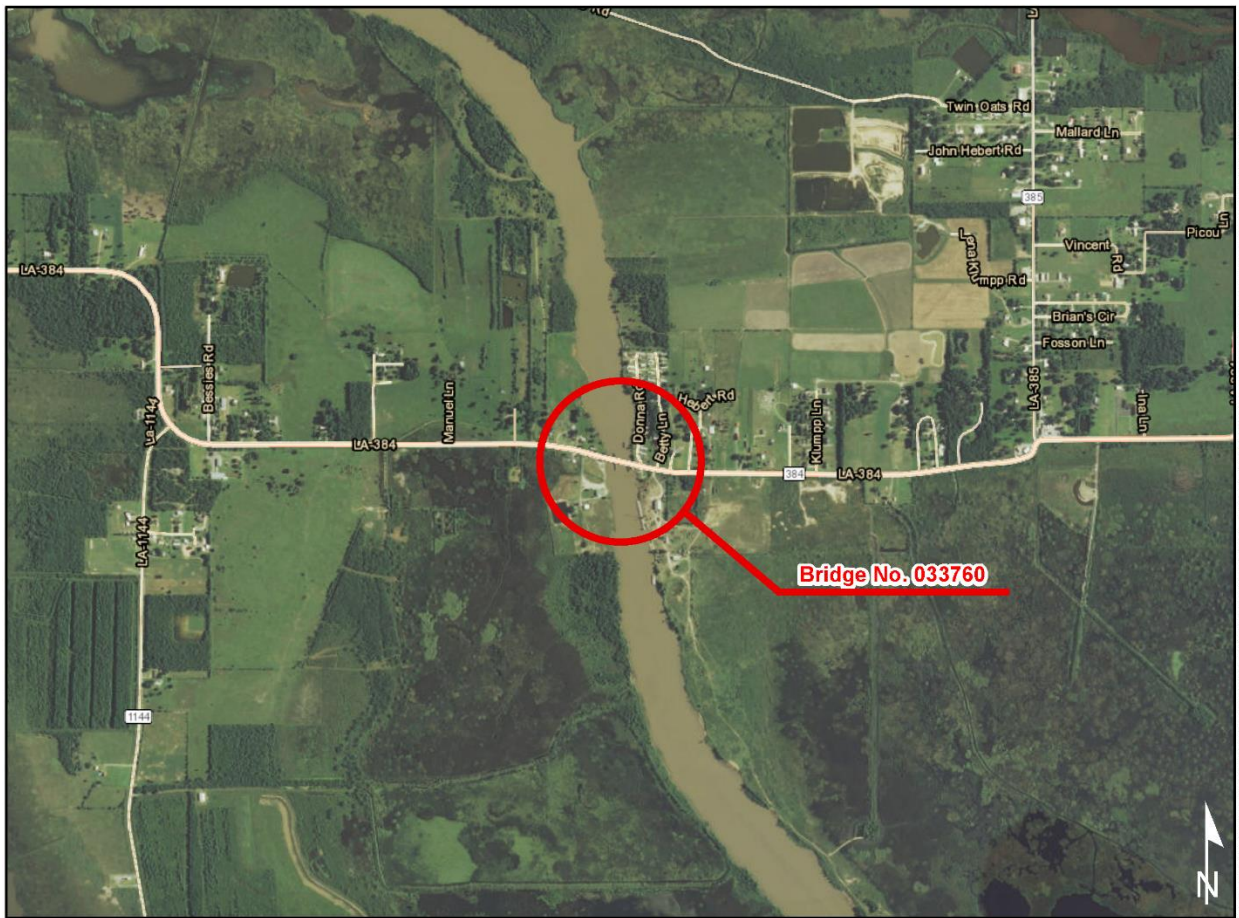

0 1,250 2,500 5,000 Feet

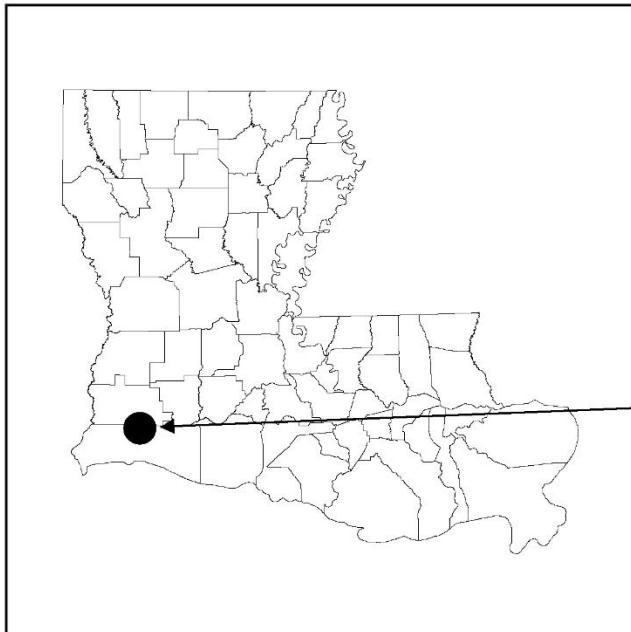

PROJECT LOCATION
Bridge Number: 033760
Structure Number: 07121953000931
Cameron Parish
Route: LA 384
Crossing Description: ICWW-Sweet/Grand Lake

THIS PAGE INTENTIONALLY LEFT BLANK

3. Historic Data

A. Identifying information

Structure Number: 07121953000931

Recall Number: 033760

LASHPO Number: 12-00208

Bridge Name: Grand Lake Pontoon Bridge

Date of Construction: 1963

Main Span Type: Movable: Pontoon Swing

Contractor: F. Miller and Sons, Inc. Lake Charles, Louisiana

Designer/Engineer: State of Louisiana, Department of Highways

B. Description of bridge

This bridge carries two lanes of LA 384 across the Intracoastal Waterway in Cameron Parish. This portion of LA 384 connects Lake Charles to the north to LA 27 east of the bridge. At this location, the Intracoastal Waterway provides access between Calcasieu Lake to the west and Sweet Lake and Grand Lake to the east of the bridge. The pontoon is at water level, which makes it susceptible to storm damage from hurricanes. The bridge was constructed in 1963, and retains nearly all elements of its original construction. For purposes of descriptions included in this Plan, the bridge is oriented east-west, and the waterway is oriented north-south. This bridge is classified as a complex structure because it contains one steel pontoon swing span.

The total length of this bridge is approximately 421 feet measured from abutment to abutment. The bridge is described as follows, from west to east. Spans 1 through 6 are cast-in-place concrete slab spans, each 20 feet long for a total length of 120 feet. Span 7 is the westerly approach apron lift span with a length of 15 feet, 6 inches. Span 8 is the main span—a pontoon swing span—with a length of 150 feet. Span 9 is the easterly approach apron lift span at 15 feet, 6 inches long. Spans 10 through 15 are cast-in-place concrete slab spans, each 20 feet long for a total length of 120 feet.

The pontoon swing span is a floating steel barge constructed of steel plates with watertight steel bulkheads providing for individual chambers within the barge. The dimensions of the pontoon barge are 150 feet long by 28 feet, 4 inches wide by 9 feet deep. The top surface of the pontoon is a 5/8-inch-thick checkered steel plate (diamond pattern) that is the driving surface for the roadway. This plate is stiffened with welded steel beams and diaphragms to support traffic loads. There is one approach apron lift span

measuring 15 feet, 6 inches in length at each end of the pontoon span. Each approach apron lift span is raised vertically by two counterweighted lift towers with sheaves and steel cables, which when open allow the pontoon to swing into the open position. When a heavy load drives across the apron at a high speed, these counterweights have a tendency to be knocked out of their pulleys. The apron spans consist of 1/2-inch-thick steel plates with a diamond pattern forming the driving surface. The apron steel plates are supported on 11 steel beams spaced at 1 foot, 4 inch centers and frame into a steel fabricated lift girder, which is attached to cables from the supporting lift towers. The steel pontoon span and the steel approach apron lift spans are painted. The substructure for the apron lift spans are concrete piers supported on concrete piles. The west and east approach spans measure 120 feet in length each and consist of six 20-foot-long, 12-inch-thick, cast-in-place, reinforced-concrete slab spans with a substructure of concrete pile bents. Two 20-foot-long, cast-in-place, reinforced-concrete roadway approach slabs are located at each end of the bridge at the abutments, and form the transition from the roadway pavement to the bridge.

The bridge provides a 24-foot clear roadway width with 1-foot-6.5-inch-wide walkways on each side of the roadway and 10-inch-high curbs. A 2-foot-high, single-line, 5-inch-diameter, horizontal, steel pipe barrier railing is attached to vertical steel I-beams, which are bolted to the outside of the approach spans and the pontoon span.

The substructure for the approach spans consist of cast-in-place, reinforced-concrete abutments (End Bents 1 and 14) supported on 14-inch square precast concrete piles, and cast-in-place, reinforced-concrete pier (bent) caps supported on 14-inch square precast concrete piles that form the columns for Bents 2, 3, 4, 5, 10, 11, 12, and 13; and on 16-inch square precast concrete piles that form the columns for Bents 6 and 9. The apron spans are supported on cast-in-place, reinforced-concrete Piers 7 and 8 supported on 18-inch square precast concrete piling.

The bridge is operated by a hydraulic equipment system located in a new enclosed structure. Hydraulic equipment replaced electrical equipment to operate winches and steel wire cables that swing the pontoon span open from a braced steel pivot arm support system located adjacent to the bridge. The pivot arm is supported on a cast-in-place, reinforced-concrete pad, which is supported on four 18-inch square precast concrete piles. The swing opening measures approximately 178 feet. The pontoon must swing open or close against current; therefore, the opening operation is not efficient. There are four pumps on the pontoon span, one in each corner, mounted on top of the walkways. The pumps are used to pump of water out of compartments of the pontoon to keep the pontoon level. These pumps are necessary for ballast adjust for proper operation of the bridge.

The operator's house and metal shed for hydraulic equipment are located to the southeast approach spans and are supported on an independent precast concrete piling foundation. A generator house is located along the shore near the southeast corner of the bridge. Both the operator's house and generator house are constructed of concrete block with longitudinal, reinforced-concrete I-beams supporting a series of reinforced-concrete channel beams that comprise the roof.

A timber fender system for waterway navigation extends into the waterway to the north and south of the pontoon span and approach apron lift spans. The timber fender system provides for a clear navigation width of 125 feet. Additionally, the pontoon is part of the fender system when in the open position, which makes it vulnerable to damage due to possible vessel impact.

Traffic gates and signals are located along the roadway at each end of the bridge. When the pontoon swing span is opened, the vertically rotated apron lift spans provide a safety barrier for vehicular traffic. The average daily traffic (ADT) across the bridge is approximately 1,950 vehicles. The bridge is opened approximately 900 times per month. The bridge is load (weight) posted at 20-35 (20 tons–35 tons), with signs indicating this located at each end of the bridge. The pontoon is sensitive to live load and may be unstable under heavy loading conditions.

C. History and significance

The Grand Lake Pontoon Bridge, located in Cameron Parish to the southeast of Deatonville, is approximately 15 miles southeast of Lake Charles. This bridge carries two lanes of LA 384 across the Intracoastal Waterway. This portion of LA 384 connects Lake Charles to the north with LA 27, and the Intracoastal Waterway provides access between Calcasieu Lake to the west of the bridge and Sweet Lake and Grand Lake to the east.

The 1963 bridge includes end posts with a recessed panel with “Intracoastal Waterway” in inscribed lettering. The Intracoastal Waterway, located along the Gulf Coast, runs for approximately 1,050 miles from Carrabelle, Florida, to Brownsville, Texas. It was constructed to provide boats and barges with a navigable channel protected from wave action. The idea of a continuous inland waterway along the Gulf Coast had been discussed since at least the 1870s. Civic leaders from the Louisiana and Texas coasts formed the Interstate Inland Waterway League in 1905, with the ambitious goal of creating a connected system of canals and waterways across the central and eastern United States, including the Gulf Coast. The organization later evolved into today’s Gulf Intracoastal Canal Association. In 1925 Congress authorized a continuous protected waterway between New Orleans and Galveston. By 1942 a series of legislative actions authorized the extension of the waterway to its current limits.¹

The bridge was designed by the Louisiana Department of Highways in 1962 and constructed in 1963. A contract for its construction was awarded to F. Miller and Sons from Lake Charles for a bid of \$332,000.²

The Grand Lake Pontoon Bridge is eligible for listing in the National Register under *Criterion C: Engineering*. Its significance is demonstrated by the presence of distinctive engineering and design

¹ Lynn Alperin, *History of the Gulf Intracoastal Waterway*, Navigation History NWS-83-9 (Fort Belvoir, Va.: National Waterways Study, U.S. Army Corps of Engineers Institute for Water Resources, March 1983), 21-28.

² "Highway Bids Received in LA," *The Times-Picayune*, Feb., 21, 1093. The Louisiana’s Department of Highway’s annual report for 1963 notes the bridge construction as Project Number 195-30-07 and indicates construction contract expenses “Financial and Statistical Report,” prepared for the State of Louisiana Department of Highways (June 30, 1963), 55.

features of a pontoon swing movable bridge. These features include a floating pontoon swing span, a pivot arm, and the approach apron lift spans on either end of the pontoon span. The bridge exhibits few alterations and retains good integrity and clearly conveys its character-defining features.

The pontoon swing is a type of movable bridge that consists of a floating pontoon that floats and swings to open a navigation channel. It was an inexpensive, simple version of a swing-span bridge. These bridges feature a pontoon span, also called a barge, positioned between the approach apron lift spans when in the closed position. A pivot arm is mounted to a pivot point, and a hand- or motor-operated system of cables, pulleys, sheaves, and winches enables and controls the movement of the pontoon. While the operating machinery is used to move the pontoon, the cables are above water level and then must be dropped into the channel bed to permit passage of marine traffic. Approach aprons enable vehicular access to the pontoon by bringing the approach roadway into alignment with the pontoon driving surface, both vertically and horizontally, when the swing span is closed. To open, the approach lift span aprons raise vertically via a motorized hoist system with counterweights housed in towers at either edge of each of the approach lift spans, and the pontoon is detached and floated open to allow navigable traffic to pass through the channel. The pontoon swing bridge is very uncommon nationally, with most examples restricted to Louisiana and Texas. While the Louisiana Department of Highways is known to have developed standard plans for metal pontoon swing bridges in 1963, the plans for the Grand Lake Pontoon Bridge do not appear to follow a standard plan.³

D. Character-defining features

Character-defining features are prominent or distinctive aspects, qualities, or characteristics of a historic property that contribute significantly to its physical character. Features may include materials, engineering design, and structural and decorative details. Elements of the bridge that are not identified as character-defining features may be historic fabric. Historic fabric is material in a bridge that was part of original construction. It is important to consider both character-defining features and the bridge's historic fabric when planning any work.

The Grand Lake Pontoon Bridge has one character-defining feature: its pontoon swing span (described below). Other elements that represent historic fabric but are not considered to be character-defining are the approach spans, including the end posts and railing; approach span substructure; operator's house; generator house; and traffic gates.

³ Mead & Hunt, Inc., *Historic Context for Louisiana Bridges* (, prepared for the Louisiana Department of Transportation and Development, December 2013), http://wwwapps.dotd.la.gov/administration/public_info/projects/docs_test/48/documents/Historic_Context_For_Louisiana_Bridges.pdf, 81-82; State of Louisiana Department of Highways, Sweet Lake Pontoon Bridge and Approaches, Intracoastal Waterway, La 384, State Project 195-30-07, December 5, 1962 (as-built plans).

The following item is the character-defining feature of this bridge:

Feature 1: Design and construction of a pontoon swing span

This feature includes the main swing span, comprised of the pontoon, the pivot arm, the two approach apron lift spans, and the four lift towers.



Character-defining Feature Photo 1: Design and construction of a pontoon swing span including the pivot arm, the two approach apron lift spans, and the four lift towers. The main swing span (closed) with floating pontoon and east apron lift span with lift towers.



Character-defining Feature Photo 2: Design and construction of a pontoon swing span including the pivot arm, the two approach apron lift spans, and the four lift towers. The main swing span (open), showing the pontoon and pivot arm.



Character-defining Feature Photo 3: Design and construction of a pontoon swing span including the pivot arm, the two approach apron lift spans, and the four lift towers. Detail of a lift tower with counterweight, sheaves, and steel cables.



Character-defining Feature Photo 4: Design and construction of a pontoon swing span including the pivot arm, the two approach apron lift spans, and the four lift towers. The approach apron lift plate shown raised vertically.

The following images illustrate other bridge features that are of historic fabric, meaning they are part of original construction but are not considered to be character-defining features:



Historic Fabric Photo 1: Concrete approach spans.



Historic Fabric Photo 2: End posts with recessed panel with "Intracoastal Waterway" in inscribed lettering.



Historic Fabric Photo 3: Operator's house (shed for hydraulic equipment in background is not considered historic fabric).



Historic Fabric Photo 4: Generator house.

4. Engineering Data

A. Existing conditions

(1) Structural observations

The Grand Lake Pontoon Bridge is in good condition overall and appears to adequately serve its purpose of carrying vehicular traffic over the waterway, with the ability to open to allow water navigation traffic to pass by the bridge. The operation of the bridge is also satisfactory as observed in the opening-closing cycle during the field visit, and the operating machinery is adequately maintained. The major deficiencies are corrosion with section loss to the counterweight guide bars and corrosion with section loss to the four counterweights.

The bridge is load (weight) posted at 20 to 35 tons (20T-35T), with signs indicating this at each end of the bridge.

Approach spans (Spans 1-6 and 10-15)

The cast-in-place, reinforced-concrete deck slabs of the approach spans are in good condition. They exhibit longitudinal cracking penetrating the entire slab with efflorescence on the underside. The deck expansion joints are in satisfactory condition. The joint material is in place and holding well with minimal build up and vegetation. The steel pipe railings are in good condition with minor localized paint system failure. The concrete substructure units (abutments and piers) are in good condition, exhibiting minor cracks, spalling, and discoloration from water staining.

Approach apron lift spans (Spans 7 and 9)

Span 7 steel apron deck is exhibiting pitting in the east lane only and the Span 9 steel apron exhibits minor rusting on the underside of the steel apron plate. Both approach aprons exhibit minor paint system failure. The Span 7 beams exhibit no major deficiencies. The Span 9 beams exhibit minimal paint system failure and corrosion at welded connections. The Span 7 lift girder is bent due to collision damage on both the south side and north side. The Span 9 lift girder exhibits corrosion at the welded connections. The open joints are in good condition, clean and free of silt and debris. The steel pipe railings are in good condition.

Pontoon swing span (Span 8)

The steel pontoon deck is in good condition, exhibiting minor pitting in the eastbound lane and the steel I-beam bumper on the northeast corner of the pontoon is bent. The paint system for the pontoon swing span is in fair condition and the four leveling pumps are in good working condition. The steel pipe railing is in good condition. The operating machinery, electrical equipment, and hydraulic equipment for the pontoon swing span are in good condition. The operating cables are in good condition, although they are submerged and have a tendency to corrode frequently.

(2) Non-structural observations

Traffic warning gates at each end of the bridge are lowered when the bridge is opened, and are in good functional and structural condition. Traffic signal lights at each end of the bridge are functioning and are in good condition.

The navigation lights are in good condition and working properly.

The horizontal and vertical geometry of the bridge is good.

The operator's house is in good condition and fully functional. The shed for the hydraulic equipment system is in good condition and fully functional. The exterior painted block of the operator's house exhibits minor mold and mildew. The interior walls have been recently painted and the front doors are new. Part of the roof system was replaced when a truck struck the building. Electric equipment was replaced in 2011 with hydraulic equipment. The hydraulic equipment is in good working condition. The generator house is in good condition, except the casing around the door is completely corroded and needs replacement. The emergency generator was not operated during the site visit.

The timber fender system is in satisfactory condition. The southeast timber fender system exhibits cracks, splits, and section loss; additionally, the majority of the metal handrail is missing. The northeast fender has worn tires attached to act as a bumper for the pontoon. Section loss includes the southeast and northwest fender systems, where both are missing a horizontal timber member. Otherwise, the fender system has been maintained to provide its function of protecting the bridge from impact loading from river navigation traffic. The navigation lights on the fenders and pontoon are in good working condition.

There are four leveling pumps, one at each corner of the pontoon span. They exhibit minor surface rust and are in good working condition.

The counterweights and counterweight guide bars for both approach apron lift spans exhibit paint failure, extensive rust, corrosion, and section loss.

(3) Serviceability observations

The ADT across of the bridge is approximately 1,950 vehicles. The bridge clear width of 24 feet provides for two lanes of traffic, one in each direction, with narrow walkways on each side of the roadway and curbs. The bridge adequately handles this traffic volume. The railing on the bridge consists of a single, steel, horizontal pipe supported by steel I-beams bolted to the structure units. The bridge is manned at all times, and is opened approximately 900 times per month.

B. Sources of information

Plans available:	Yes, available at the LADOTD Bridge Section office
Inspection report date:	June 8, 2015
Fracture critical report date:	(included as part of routine inspection report)
Underwater inspection report:	May 27, 2014
Date of site visit:	February 2, 2016



Condition Photo 1: Overview of pontoon swing span.



Condition Photo 2: Typical approach apron lift span showing steel plate rotated vertically.



Condition Photo 3: Traffic warning gates and signals at the east approach roadway.



Condition Photo 4: Discoloration from water staining on substructure and curb and condition of steel railing (west approach spans shown).



Condition Photo 5: Condition of approach apron lift tower. Rust, corrosion, and section loss on counterweight and counterweight guide bars typical for four counterweights.



Condition Photo 6: Debris and vegetation on bridge deck, typical on approach spans. Photo also shows condition of railing.



Condition Photo 7: Pontoon pump, one on each corner of pontoon span. The surface rust on the leveling pump and platform is typical for all four pumps.



Condition Photo 8: Localized paint failure on steel pipe railing, typical throughout the bridge.



Condition Photo 9: Minor pitting in steel deck on eastbound traffic lane of the pontoon swing span.



Condition Photo 10: Operator's house exterior condition, with hydraulic equipment shed in background.



Condition Photo 11: Operator's house and hydraulic equipment shed exterior condition. Also note hydraulically operated winch mounted on pile supported platform.



Condition Photo 12: Generator house exterior condition.



Condition Photo 13: Pontoon swing span in the open position showing pivot arm and support for the pivot arm.



Condition Photo 14: Operating machinery, hydraulically operated winch and cable system, including foundation supports. Note: the winch has been replaced with a system that keeps the cables out of the water.



Condition Photo 15: Missing horizontal member and metal railing on southeast timber fender.

5. Recommendations

This Preservation Priority Bridge should remain in use and can meet current and projected transportation needs for the next 20 years or more. Maintenance and rehabilitation activities should be completed in a manner consistent with the long-term preservation of this historic bridge. The Statewide Historic Bridge Plan provides additional guidance and approaches to completing maintenance and rehabilitation activities that adhere to the Secretary's Standards. Work should be conducted under the supervision of a qualified professional historian, as defined in the PA. The bridge engineer, or the bridge engineer's supervising engineer, should have demonstrated expertise in historic bridge projects and must have completed the LADOTD's historic bridge training. When developing plans and specifications for a project, the bridge engineer should follow the recommendations below.

Under the terms agreed upon in the PA, the bridge owner may undertake certain activities that are considered to be best practices without additional consultation or public notification. These activities are documented in Attachment 5 of the PA and are limited to the activities specifically noted. All recommended preventative maintenance and rehabilitation activities for this bridge are included in Attachment 5 and are not expected to alter character-defining features or historic fabric of the bridge. Some cyclical or condition-based maintenance items are noted below under Rehabilitation because they are expected to be completed as part of an overall rehabilitation project for this bridge. These activities may need to be completed as conditions dictate to promote long-term preservation of this historic bridge. Recommendations within this Plan should be reviewed in 10 years following completion of the Plan to identify any needed updates or revisions

The opinions of probable costs provided below are in 2016 dollars. The costs were developed without benefit of preliminary rehabilitation plans and are based on the above identified tasks using engineering judgment and/or gross estimates of quantities and historic unit prices and are intended to provide a programming level of estimated costs. Refinement of the probable costs is recommended once preliminary plans have been developed. The estimated preservation costs include a 10% contingency and 7% mobilization allowance of the preservation activities, excluding soft costs. Actual costs may vary significantly from those opinions of cost provided herein. Engineering design, historical consultation, and construction administration costs are not included as these may be provided by the owner or consultants.

A. Preventative maintenance

The following are recommendations for cyclical maintenance. Because these activities are routinely done, the cost is not included in the cost estimate. There are no condition-based maintenance recommendations at this time, based on the bridge condition as observed during the site visit and as documented in available information.

1. Clean out debris and vegetation at the edge of the bridge deck annually.
2. Remove and replace the casing for the door on the generator house.
3. Remove and replace timber fenders that exhibit section loss within the next year. Monitor and replace timber fenders that exhibit cracks and splits. Monitor and replace tires as necessary for the fender protection system.

4. Monitor the pitting on the pontoon swing span deck annually.
5. Remove and replace the operating cables as necessary.

B. Rehabilitation

The following are recommendations for rehabilitation. These activities should be performed when necessary (estimated to be within the next two years):

1. Clean and spot paint steel pipe railing, leveling pumps, steel beams, and lift girder connections where necessary.
2. Clean and patch concrete spalling on concrete substructure units.
3. Remove and replace the counterweight guide bars for the four counterweights.
4. Clean and paint the four counterweights.
5. Remove and replace metal railing system on timber fender.

Bridge Recall No. 033760		Date:	7/11/2016	
Grand Lake Pontoon Bridge				
Opinion of Probable Costs				
Rehabilitation				
Item	Quantity	Unit	Unit Cost	Total
Spot clean and paint metal railings, leveling pumps, stringer and lifting girder connections (near white finish, includes containment)	1	LS	\$100,000	\$100,000
Clean and patch concrete spalls on substructure units	1	LS	\$150,000	\$150,000
Remove and replace guides bars for counterweights	4	EA	\$10,000	\$40,000
Clean (near white finish) and paint counterweights	4	EA	\$2,500	\$10,000
Remove and replace metal railing system on timber fender	1	LS	\$2,500	\$2,500
Item Subtotal				\$302,500
Contingency			10.00%	\$30,250
Mobilization			7.00%	\$23,293
TOTAL ESTIMATED CONSTRUCTION COST				\$356,043
			Round to:	\$356,000

C. Identification of any anticipated design exceptions

No design exceptions were noted, nor are any design exceptions recommended.

Appendix A. Historic Inventory Form

THIS PAGE INTENTIONALLY LEFT BLANK

Louisiana Historic Bridge Inventory

Recall Number: 033760

Structure Number: 07121953000931

SHPO Number: 12-00208

Bridge Name: GRAND LAKE PONTOON

Location Data:

District: 07

Parish: Cameron

Feature Crossed: ICWW-SWEET/GRAND LAKE

Facility Carried: LA0384

Location: .93 MI. W OF INT LA385

City, Village or Town (if applicable):

Status: Open

Bridge Owner: State of Louisiana

Latitude: 30.010917

Longitude: -93.228133

Structural Data:

Bridge Type: Pontoon Bridge

Year Built: 1963

Main Span Configuration (if applicable): Pontoon swing

Maximum Span Length (feet): 150

Number of Spans: 1

Overall Structure Length (feet): 421

Approach Span Type (if applicable): Concrete slab

Posted Load: 20-35

Current ADT: 001950

Design and Construction Data:

Engineer or Builder:

Unknown

Bridge Plaque:

None

National Register of Historic Places Evaluation:

This pontoon swing bridge has significance as a distinctive example of a movable bridge. Its significance is demonstrated by the presence of distinctive engineering and design features of the pontoon swing bridge type, which is characterized by a floating pontoon span, pivot arm, and mechanical systems to operate the movement of the pontoon and approach aprons. The bridge retains good integrity and clearly conveys the significant features of the pontoon swing bridge type. This bridge is eligible for listing in the National Register under Criterion C: Design/Engineering.

No evidence was found during research or data collection activities to indicate that this bridge possesses a direct and important association with historical events or trends. This bridge does not possess significance under Criterion A.

Within/Adjacent to Known Historic District: N/A

National Register Historic District Name: N/A

National Register Determination: Eligible

National Register Determination Date: 2013

Surveyor: Mead & Hunt, Inc.

Date Surveyed: 2013



Louisiana Historic Bridge Inventory

Recall Number: 033760

Structure Number: 07121953000931

Bridge Name: GRAND LAKE PONTOON

Parish: Cameron

Bridge Owner: State of Louisiana

Feature Crossed: ICWW-SWEET/GRAND LAKE

Facility Carried: LA0384

Photographs:



Appendix B. Select Plan Sheets

THIS PAGE INTENTIONALLY LEFT BLANK

62

SECTION 18 T125 RBW
SOUTHWESTERN LAND
DISTRICT

STATE PROJECT	PARISH	SHEET NO.
188-30-07	CAMERON	7

CURVE DATA:
(PROJECTED & ADAPTED S.)
 1. AL JTA 44+50.07
 2. 71+25.47
 3. 67+30
 4. 83+82.45
 5. 101+408.5
 6. 1273.000
 (No Superelevation)

NOTE:
See Sheet N1 10 for
Complete Layout of
Projected & Adapted S.

NOTE:
See Sheet N1 9 for Location of
Channel involved in Limits of
Project

NOTE:
Name of Waterway and Date of
Construction Required Each End of
Bridges.
J.C.C. Plan C.1170 & C.1171

NOTE:
See Sheet N1 8 for Details
of Plans, A.C. Curve, Page 6, June
See Required at Each End of Bridge.

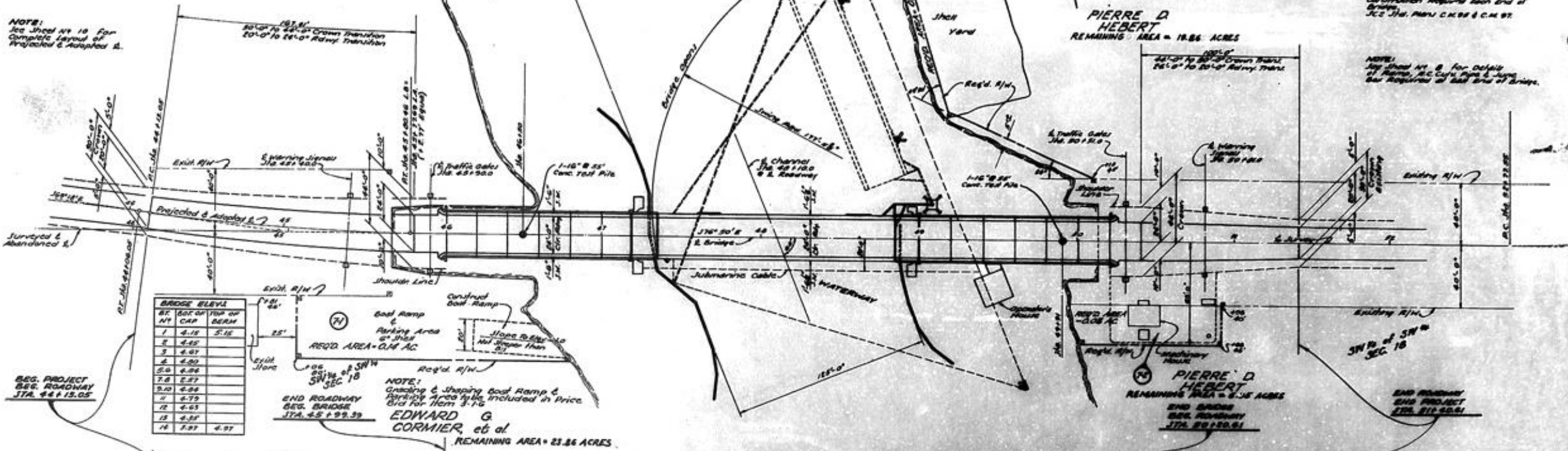

ST. NO.	TOP OF CAP	TOP OF BERM
1	4.15	5.16
2	4.45	
3	4.67	
4	4.90	
5	4.96	
6	4.99	
7	4.97	
8	4.98	
9	4.99	
10	4.99	
11	4.99	
12	4.99	
13	4.99	
14	4.99	

NOTE:
Grading & Shaping Road Ramp &
Shoulder Area to be Included in Price
Bid for Item 3.12
**EDWARD G
CORMIER, et al**
REMAINING AREA = 23.86 ACRES

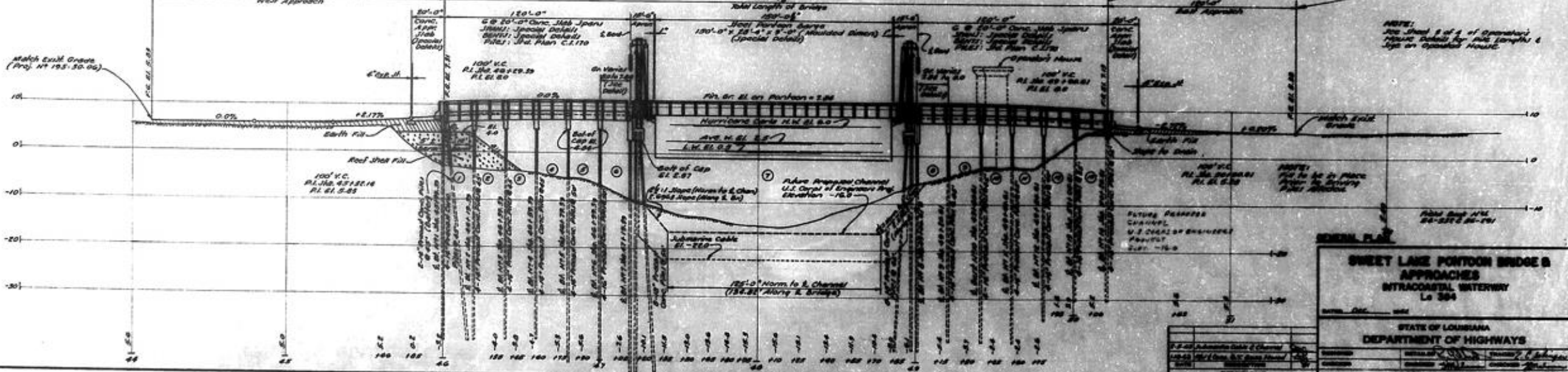

GENERAL PLAN

SWEET LAKE PORTON BRIDGE & APPROACHES
INTRACOSTAL WATERWAY
Ls 384

STATE OF LOUISIANA
DEPARTMENT OF HIGHWAYS

DESIGNED BY: [Signature]
CHECKED BY: [Signature]
DATE: [Date]

FINAL TRACINGS



83

STATE PROJECT	PARISH	SHEET NO.
188-30-07	CAMERON	28

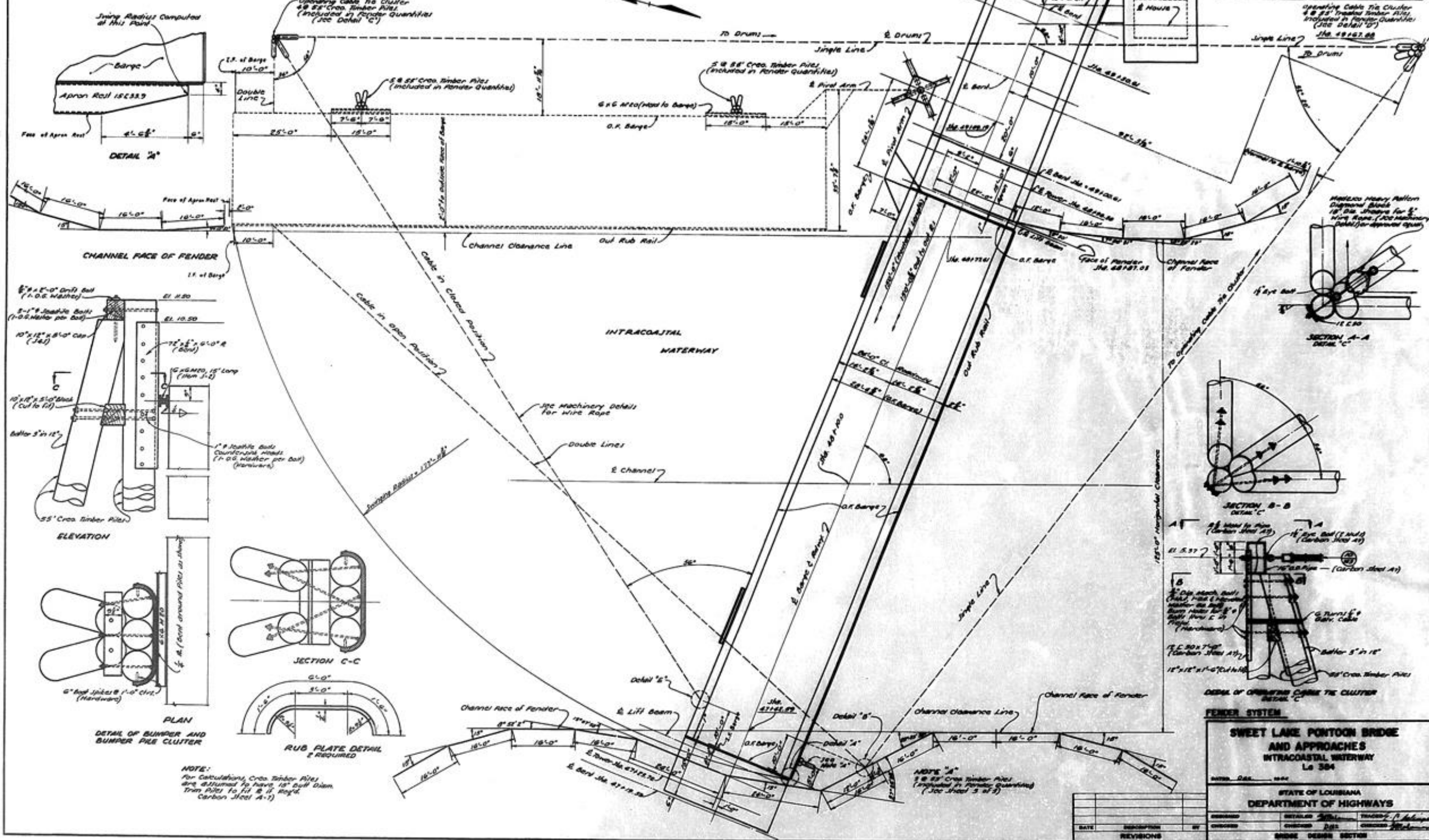

FINAL TRACINGS



DATE	DESCRIPTION	BY

SWEET LAKE PONTOON BRIDGE AND APPROACHES
INTRACOASTAL WATERWAY
 Ls 384

STATE OF LOUISIANA
 DEPARTMENT OF HIGHWAYS

BRIDGE DESIGN SECTION

23-

STATE PROJECT	PARISH	SHEET NO.
195-30-07	CAMERON	11/2

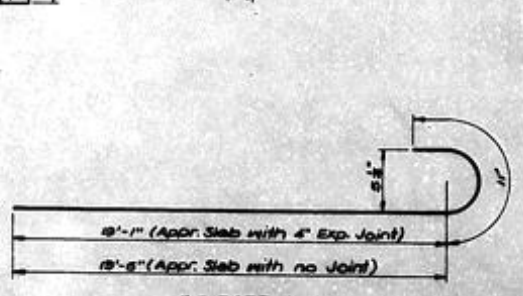
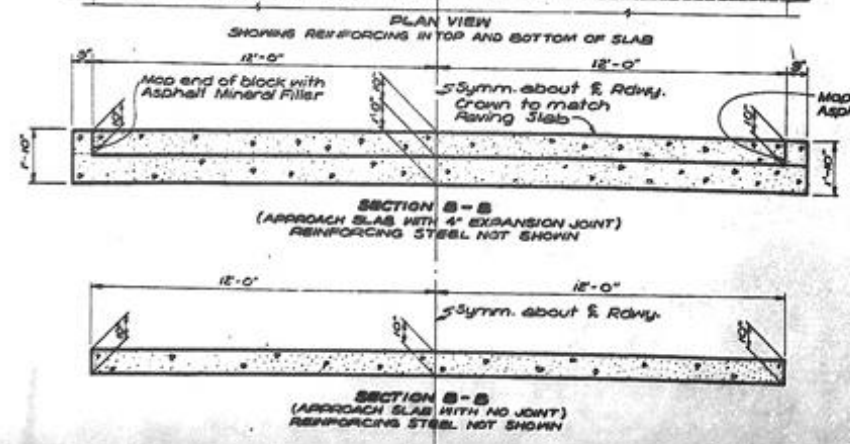
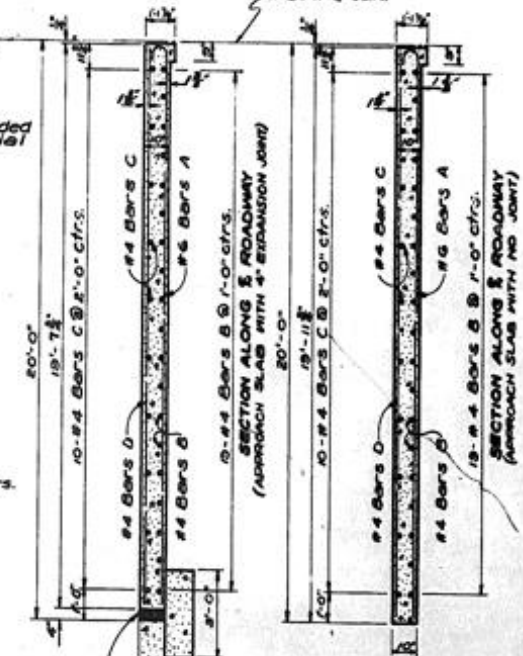
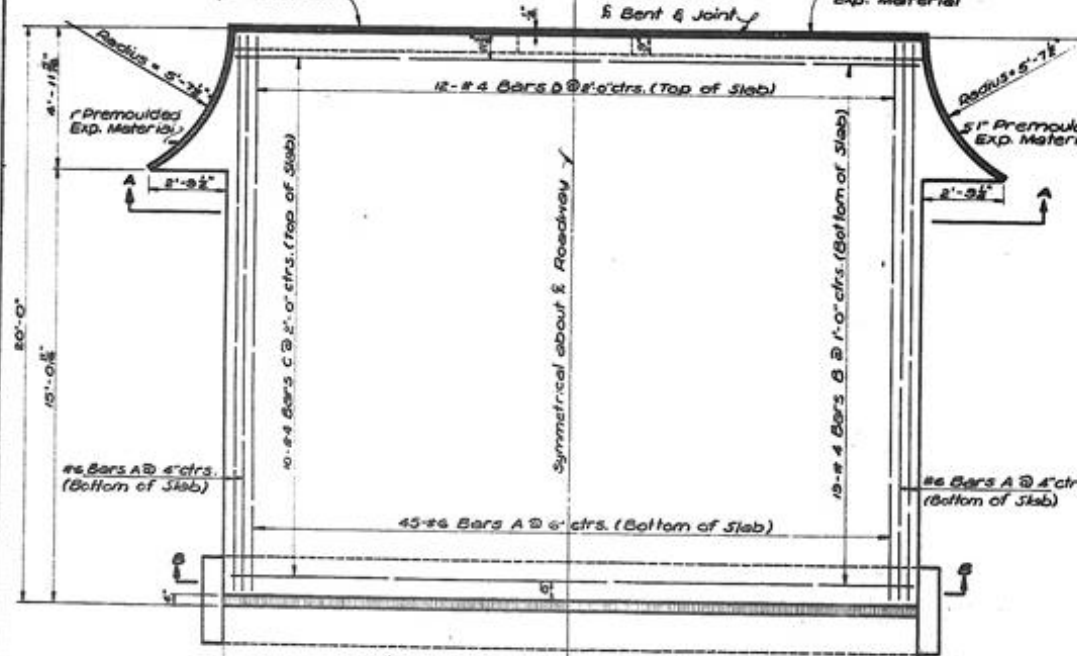
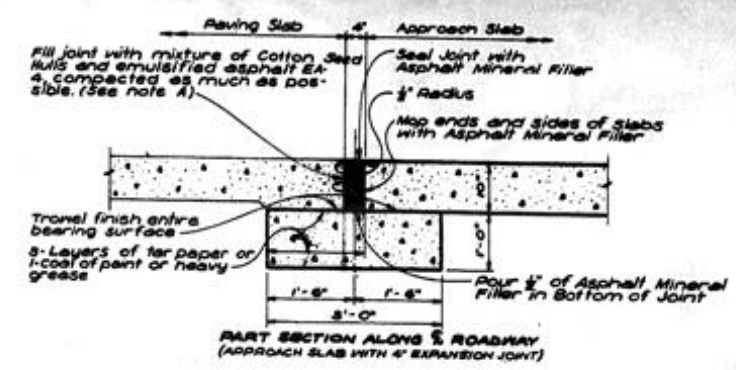
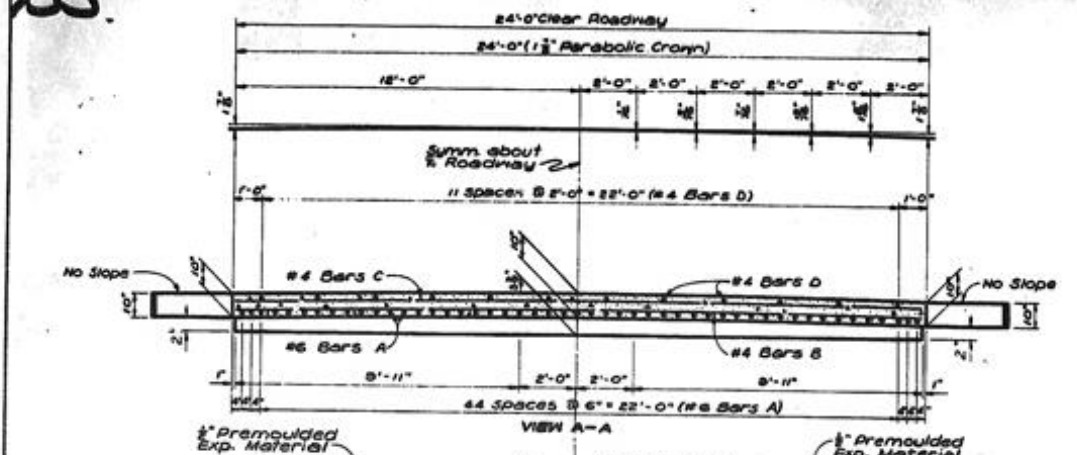

**BILL OF MATERIALS FOR ONE SLAB (WITH 4\"/>

BAR	NO.	UNIT	TOTAL LENGTH	LOCATION
A	#4 48	20'-0"	960'-0"	Bottom of Slab
B	#4 18	22'-6"	449'-6"	Bottom of Slab
C	#4 10	22'-6"	229'-6"	Top of Slab
D	#4 12	18'-4"	220'-0"	Top of Slab

TOTAL #4 BARS = 516'-0" = 516 LBS.
 DEFORMED REINFORCING STEEL = 2025 LBS.
 CONCRETE APPROACH SLAB = 282 CY.
 CLASS "A" CONCRETE (BLOCK ONLY) = 227 CY.
 APPROACH SLAB EXPANSION FILLER = 228 CU FT.**

BILL OF MATERIALS FOR ONE SLAB (WITH NO JOINT)

BAR	NO.	UNIT	TOTAL LENGTH	LOCATION
A	#4 48	20'-4"	964'-4"	Bottom of Slab
B	#4 18	22'-0"	449'-0"	Bottom of Slab
C	#4 10	22'-6"	229'-6"	Top of Slab
D	#4 12	12'-6"	228'-0"	Top of Slab

TOTAL #4 BARS = 522'-4" = 516 LBS.
 DEFORMED REINFORCING STEEL = 2112 LBS.
 CONCRETE APPROACH SLAB = 282 CY.

GENERAL NOTES:
 Construction Specifications: Latest approved La. Dept. of Highways Standard Specifications.
 Design Specifications: A.A.S.H.O. 1961 as amended to Sept. 1961 Reinforcement Bars shall be intermediate or hard grade, A.S.T.M. A15, or rail steel, A.S.T.M. A16, conforming to A.S.T.M. A305. Dimensions relating to Reinforcing Steel are to Bar Centers. Concrete to be Class "A" or may be same mix as adjoining Raving Slab.
 1" and 1/2" Preformed Expansion Material and Approach Slab Expansion Joint Filler to be included in price bid for Concrete Approach Slab.

NOTE A:
 Mixture for Filler shall be approx. 0.5 gal. emulsified asphalt EA-4 per cubic foot of cotton seed hulls measured loose. One cubic foot of cotton seed hulls measured loose weighs approx. 10.5 lbs. Mixture shall be permitted to age a minimum of 48 hours before placing in joint.

$$(3 \times 12 \times 25 \times 6) \times (28.5 \times 22 + 710) = 14000 \times 2.172$$

APPROACH SLAB

SWEET LAKE PONTOON BRIDGE AND APPROACHES
 INTRACOASTAL WATERWAY
 Ls 384

DATED June 14, 1964

STATE OF LOUISIANA
 DEPARTMENT OF HIGHWAYS

DESIGNED BY: [Signature]
 CHECKED BY: [Signature]
 APPROVED BY: [Signature]

Robert [Signature]



156

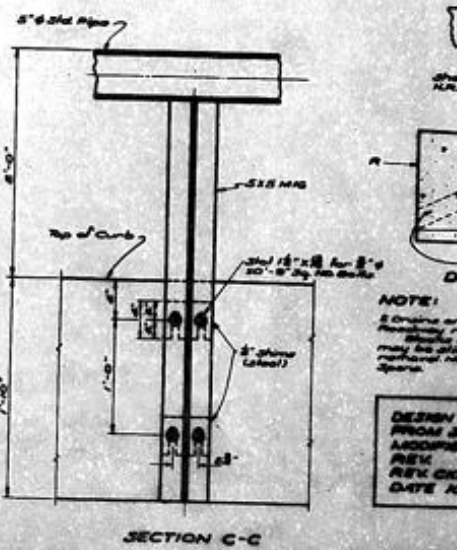
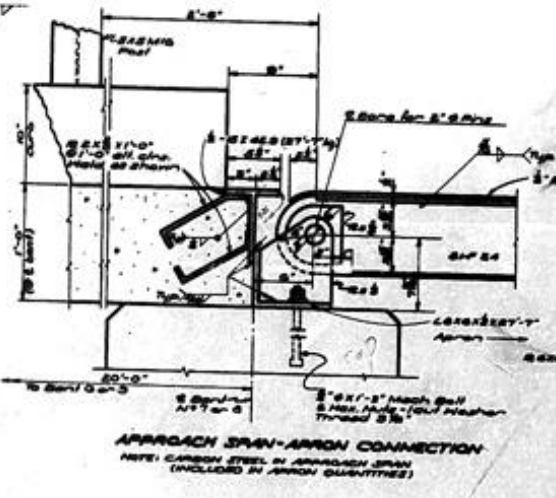
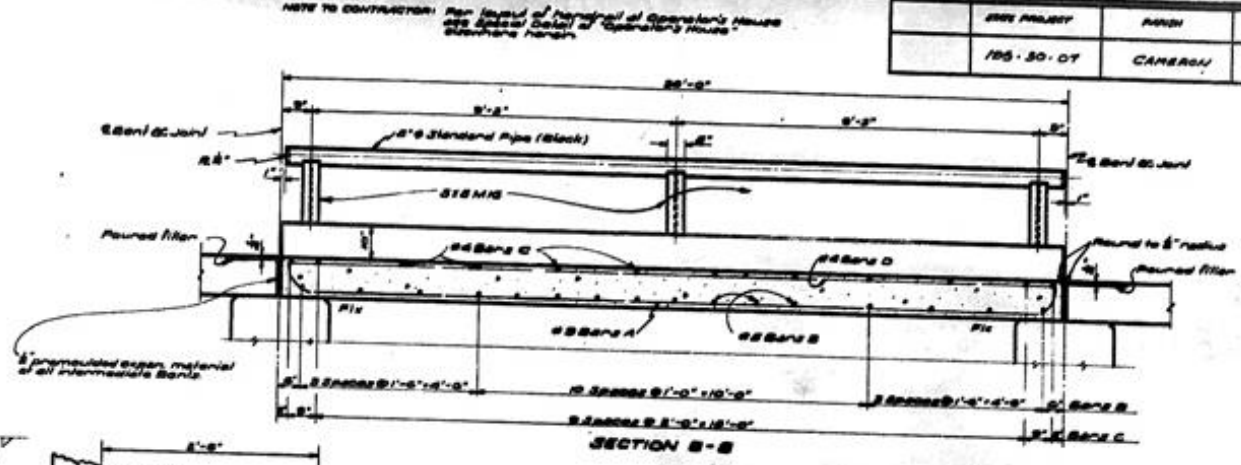
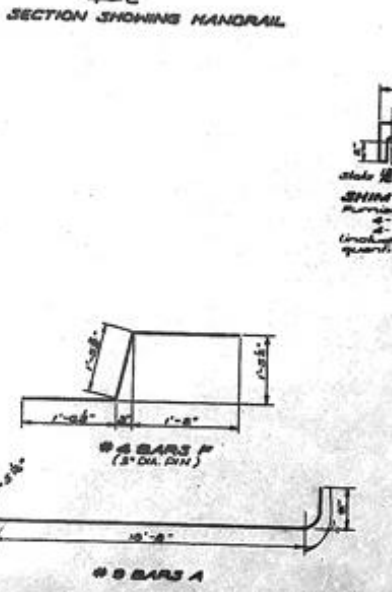
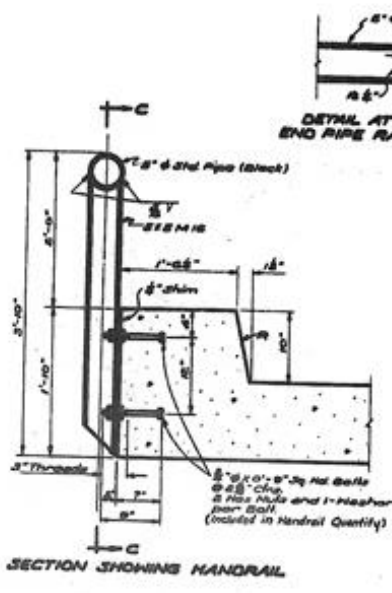
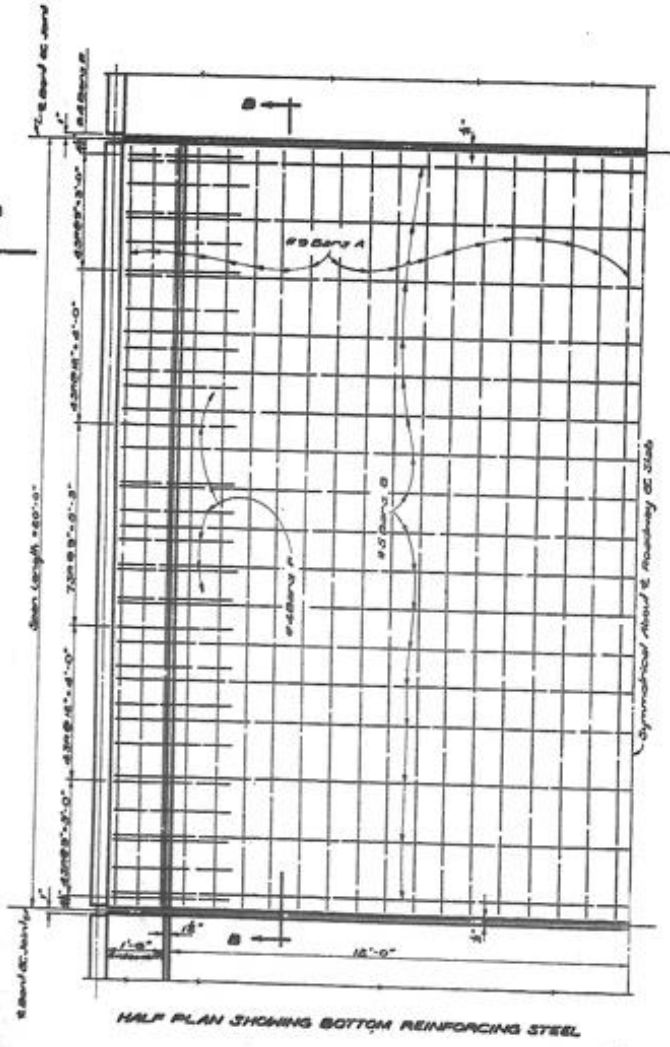
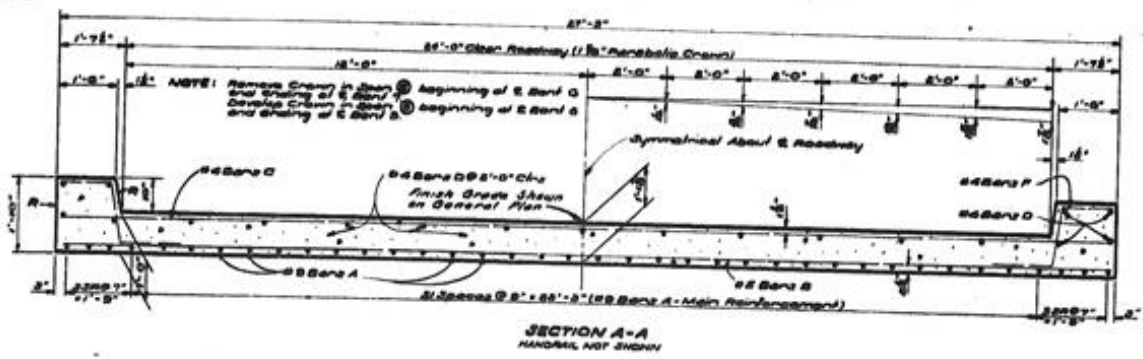

BILL OF MATERIALS FOR ONE SPAN					
BAR	SIZE	N ^o	LENGTH	TOTAL LENGTH	LOCATION
A	#4	25	20'-0"	700'-0"	Bottom of slab
Total #4 Bars = 700'-0"					
B	#4	17	20'-0"	427'-0"	Bottom of slab
Total #4 Bars = 427'-0"					
C	#4	12	20'-0"	324'-0"	Top of slab
D	#4	12	19'-0"	318'-0"	Top of slab & curb
E	#4	46	4'-0"	504'-0"	Curb
Total #4 Bars = 504'-0"					
TOTAL REINFORCING STEEL					
TOTAL CLASS "A" CONCRETE SPANS 1-5 60'-0" 360'-0" LBS					
TOTAL CLASS "A" CONCRETE SPANS 6-8 225'-0" 225'-0" LBS					
TOTAL HANDRAIL SPANS 1-8 60'-0" 60'-0" LBS					
TOTAL HANDRAIL SPANS 9-8 225'-0" 225'-0" LBS					

GENERAL NOTES:
 Construction Specifications
 Latest Approved to Dept of Highways
 Design Specifications A.S.T.M. A 662 as amended to Dec 31 1952
 Use Class 110-40
 All concrete to be Class 110
 Expansion joints to have 1/2" clearance for lateral movement
 Reinforcement bars shall be intermediate or hand
 twisted A.S.T.M. A 662 or Rod Steel A.S.T.M. A 675
 Bars to be bent 90° and to be bent 45°
 Detailing shall be in accordance with the provisions of A.S.T.M. A 662
 in all cases for concrete spans to be provided in every
 particular case. Making steel connections to spans for hand
 rail and roadway bridge of the American Highway Society, Inc.
 # - Standard Class & Finish
 # - Includes Material for the Operable House.
 All Anchor Bolts and Nuts to be Hot-Dipped Galvanized.
 # - Size: weight per foot by A.S.T.M. A 662

DESIGN AND DETAIL TAKEN FROM S.A. 225-01-55 AND ADAPTED TO FIT THIS PROJECT
 REV. 5/24/55
 R.T.K. ENG. CO. INC.
 DATE 10-5-52

SPANS 1 THRU 8 & 9 THRU 13
SWEET LAKE PONTOON BRIDGE AND APPROACHES
 INTRACOASTAL WATERWAY
 Lc 394
 DATE: DEC. 3, 1952
 STATE OF LOUISIANA
 DEPARTMENT OF HIGHWAYS
 BRIDGE DESIGN SECTION



157

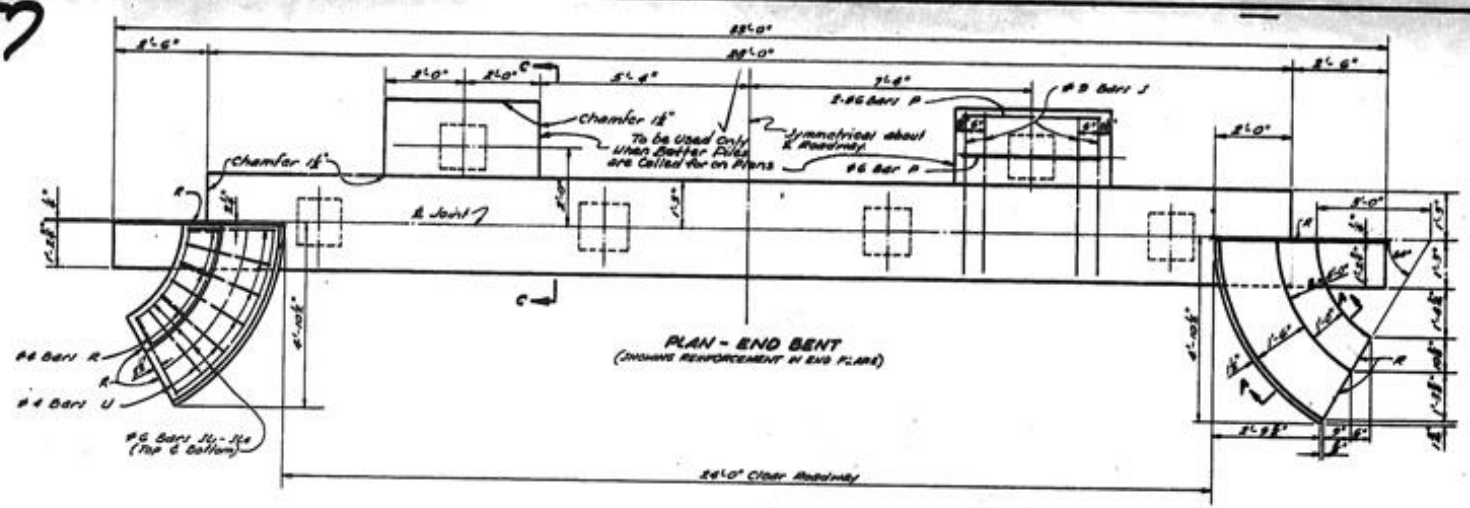

Bar 1, 2, 3, 4, 13, 14, 15, 16
 Bar 5, 6, 7, 10, 11, 12
 Bar 7-8

Except for Correction as indicated for 'Z' bars below: 'Z' bars placed in Plan Section.

STATE PROJECT	PIER	SHEET NO.
186-30-07	CANBOU	13 1/4

BILL OF MATERIALS BENTS 1 OR 16 (ONE BENT)				
BAR SIZE	NO.	LENGTH	WEIGHT	LOCATION
#6	1	18'-0"	11.0	Along in Cap
#6	2	18'-0"	11.0	Along in Cap
#6	3	18'-0"	11.0	Along in Cap
#6	4	18'-0"	11.0	Along in Cap
#6	5	18'-0"	11.0	Along in Cap
#6	6	18'-0"	11.0	Along in Cap
#6	7	18'-0"	11.0	Along in Cap
#6	8	18'-0"	11.0	Along in Cap
#6	9	18'-0"	11.0	Along in Cap
#6	10	18'-0"	11.0	Along in Cap
#6	11	18'-0"	11.0	Along in Cap
#6	12	18'-0"	11.0	Along in Cap
#6	13	18'-0"	11.0	Along in Cap
#6	14	18'-0"	11.0	Along in Cap
#6	15	18'-0"	11.0	Along in Cap
#6	16	18'-0"	11.0	Along in Cap
#6	17	18'-0"	11.0	Along in Cap
#6	18	18'-0"	11.0	Along in Cap
#6	19	18'-0"	11.0	Along in Cap
#6	20	18'-0"	11.0	Along in Cap
#6	21	18'-0"	11.0	Along in Cap
#6	22	18'-0"	11.0	Along in Cap
#6	23	18'-0"	11.0	Along in Cap
#6	24	18'-0"	11.0	Along in Cap
#6	25	18'-0"	11.0	Along in Cap
#6	26	18'-0"	11.0	Along in Cap
#6	27	18'-0"	11.0	Along in Cap
#6	28	18'-0"	11.0	Along in Cap
#6	29	18'-0"	11.0	Along in Cap
#6	30	18'-0"	11.0	Along in Cap
#6	31	18'-0"	11.0	Along in Cap
#6	32	18'-0"	11.0	Along in Cap
#6	33	18'-0"	11.0	Along in Cap
#6	34	18'-0"	11.0	Along in Cap
#6	35	18'-0"	11.0	Along in Cap
#6	36	18'-0"	11.0	Along in Cap
#6	37	18'-0"	11.0	Along in Cap
#6	38	18'-0"	11.0	Along in Cap
#6	39	18'-0"	11.0	Along in Cap
#6	40	18'-0"	11.0	Along in Cap
#6	41	18'-0"	11.0	Along in Cap
#6	42	18'-0"	11.0	Along in Cap
#6	43	18'-0"	11.0	Along in Cap
#6	44	18'-0"	11.0	Along in Cap
#6	45	18'-0"	11.0	Along in Cap
#6	46	18'-0"	11.0	Along in Cap
#6	47	18'-0"	11.0	Along in Cap
#6	48	18'-0"	11.0	Along in Cap
#6	49	18'-0"	11.0	Along in Cap
#6	50	18'-0"	11.0	Along in Cap
#6	51	18'-0"	11.0	Along in Cap
#6	52	18'-0"	11.0	Along in Cap
#6	53	18'-0"	11.0	Along in Cap
#6	54	18'-0"	11.0	Along in Cap
#6	55	18'-0"	11.0	Along in Cap
#6	56	18'-0"	11.0	Along in Cap
#6	57	18'-0"	11.0	Along in Cap
#6	58	18'-0"	11.0	Along in Cap
#6	59	18'-0"	11.0	Along in Cap
#6	60	18'-0"	11.0	Along in Cap
#6	61	18'-0"	11.0	Along in Cap
#6	62	18'-0"	11.0	Along in Cap
#6	63	18'-0"	11.0	Along in Cap
#6	64	18'-0"	11.0	Along in Cap
#6	65	18'-0"	11.0	Along in Cap
#6	66	18'-0"	11.0	Along in Cap
#6	67	18'-0"	11.0	Along in Cap
#6	68	18'-0"	11.0	Along in Cap
#6	69	18'-0"	11.0	Along in Cap
#6	70	18'-0"	11.0	Along in Cap
#6	71	18'-0"	11.0	Along in Cap
#6	72	18'-0"	11.0	Along in Cap
#6	73	18'-0"	11.0	Along in Cap
#6	74	18'-0"	11.0	Along in Cap
#6	75	18'-0"	11.0	Along in Cap
#6	76	18'-0"	11.0	Along in Cap
#6	77	18'-0"	11.0	Along in Cap
#6	78	18'-0"	11.0	Along in Cap
#6	79	18'-0"	11.0	Along in Cap
#6	80	18'-0"	11.0	Along in Cap
#6	81	18'-0"	11.0	Along in Cap
#6	82	18'-0"	11.0	Along in Cap
#6	83	18'-0"	11.0	Along in Cap
#6	84	18'-0"	11.0	Along in Cap
#6	85	18'-0"	11.0	Along in Cap
#6	86	18'-0"	11.0	Along in Cap
#6	87	18'-0"	11.0	Along in Cap
#6	88	18'-0"	11.0	Along in Cap
#6	89	18'-0"	11.0	Along in Cap
#6	90	18'-0"	11.0	Along in Cap
#6	91	18'-0"	11.0	Along in Cap
#6	92	18'-0"	11.0	Along in Cap
#6	93	18'-0"	11.0	Along in Cap
#6	94	18'-0"	11.0	Along in Cap
#6	95	18'-0"	11.0	Along in Cap
#6	96	18'-0"	11.0	Along in Cap
#6	97	18'-0"	11.0	Along in Cap
#6	98	18'-0"	11.0	Along in Cap
#6	99	18'-0"	11.0	Along in Cap
#6	100	18'-0"	11.0	Along in Cap



#6 Bars 17-20 (Top & Bottom)

#6 Bars 21-24 (Top & Bottom)

#6 Bars 25-28 (Top & Bottom)

#6 Bars 29-32 (Top & Bottom)

#6 Bars 33-36 (Top & Bottom)

#6 Bars 37-40 (Top & Bottom)

#6 Bars 41-44 (Top & Bottom)

#6 Bars 45-48 (Top & Bottom)

#6 Bars 49-52 (Top & Bottom)

#6 Bars 53-56 (Top & Bottom)

#6 Bars 57-60 (Top & Bottom)

#6 Bars 61-64 (Top & Bottom)

#6 Bars 65-68 (Top & Bottom)

#6 Bars 69-72 (Top & Bottom)

#6 Bars 73-76 (Top & Bottom)

#6 Bars 77-80 (Top & Bottom)

#6 Bars 81-84 (Top & Bottom)

#6 Bars 85-88 (Top & Bottom)

#6 Bars 89-92 (Top & Bottom)

#6 Bars 93-96 (Top & Bottom)

#6 Bars 97-100 (Top & Bottom)

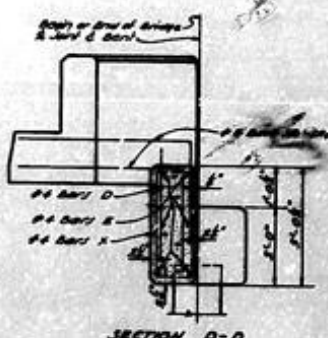
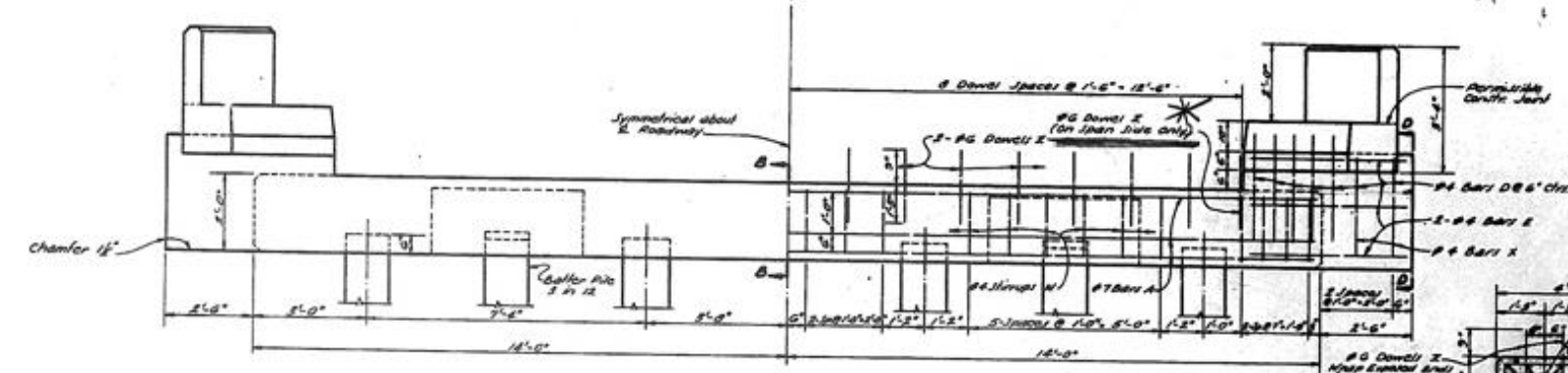

BILL OF MATERIALS BENTS 2-8 OR 9-16 (ONE BENT)				
BAR SIZE	NO.	LENGTH	WEIGHT	LOCATION
#6	1	18'-0"	11.0	Along in Cap
#6	2	18'-0"	11.0	Along in Cap
#6	3	18'-0"	11.0	Along in Cap
#6	4	18'-0"	11.0	Along in Cap
#6	5	18'-0"	11.0	Along in Cap
#6	6	18'-0"	11.0	Along in Cap
#6	7	18'-0"	11.0	Along in Cap
#6	8	18'-0"	11.0	Along in Cap
#6	9	18'-0"	11.0	Along in Cap
#6	10	18'-0"	11.0	Along in Cap
#6	11	18'-0"	11.0	Along in Cap
#6	12	18'-0"	11.0	Along in Cap
#6	13	18'-0"	11.0	Along in Cap
#6	14	18'-0"	11.0	Along in Cap
#6	15	18'-0"	11.0	Along in Cap
#6	16	18'-0"	11.0	Along in Cap
#6	17	18'-0"	11.0	Along in Cap
#6	18	18'-0"	11.0	Along in Cap
#6	19	18'-0"	11.0	Along in Cap
#6	20	18'-0"	11.0	Along in Cap
#6	21	18'-0"	11.0	Along in Cap
#6	22	18'-0"	11.0	Along in Cap
#6	23	18'-0"	11.0	Along in Cap
#6	24	18'-0"	11.0	Along in Cap
#6	25	18'-0"	11.0	Along in Cap
#6	26	18'-0"	11.0	Along in Cap
#6	27	18'-0"	11.0	Along in Cap
#6	28	18'-0"	11.0	Along in Cap
#6	29	18'-0"	11.0	Along in Cap
#6	30	18'-0"	11.0	Along in Cap
#6	31	18'-0"	11.0	Along in Cap
#6	32	18'-0"	11.0	Along in Cap
#6	33	18'-0"	11.0	Along in Cap
#6	34	18'-0"	11.0	Along in Cap
#6	35	18'-0"	11.0	Along in Cap
#6	36	18'-0"	11.0	Along in Cap
#6	37	18'-0"	11.0	Along in Cap
#6	38	18'-0"	11.0	Along in Cap
#6	39	18'-0"	11.0	Along in Cap
#6	40	18'-0"	11.0	Along in Cap
#6	41	18'-0"	11.0	Along in Cap
#6	42	18'-0"	11.0	Along in Cap
#6	43	18'-0"	11.0	Along in Cap
#6	44	18'-0"	11.0	Along in Cap
#6	45	18'-0"	11.0	Along in Cap
#6	46	18'-0"	11.0	Along in Cap
#6	47	18'-0"	11.0	Along in Cap
#6	48	18'-0"	11.0	Along in Cap
#6	49	18'-0"	11.0	Along in Cap
#6	50	18'-0"	11.0	Along in Cap
#6	51	18'-0"	11.0	Along in Cap
#6	52	18'-0"	11.0	Along in Cap
#6	53	18'-0"	11.0	Along in Cap
#6	54	18'-0"	11.0	Along in Cap
#6	55	18'-0"	11.0	Along in Cap
#6	56	18'-0"	11.0	Along in Cap
#6	57	18'-0"	11.0	Along in Cap
#6	58	18'-0"	11.0	Along in Cap
#6	59	18'-0"	11.0	Along in Cap
#6	60	18'-0"	11.0	Along in Cap
#6	61	18'-0"	11.0	Along in Cap
#6	62	18'-0"	11.0	Along in Cap
#6	63	18'-0"	11.0	Along in Cap
#6	64	18'-0"	11.0	Along in Cap
#6	65	18'-0"	11.0	Along in Cap
#6	66	18'-0"	11.0	Along in Cap
#6	67	18'-0"	11.0	Along in Cap
#6	68	18'-0"	11.0	Along in Cap
#6	69	18'-0"	11.0	Along in Cap
#6	70	18'-0"	11.0	Along in Cap
#6	71	18'-0"	11.0	Along in Cap
#6	72	18'-0"	11.0	Along in Cap
#6	73	18'-0"	11.0	Along in Cap
#6	74	18'-0"	11.0	Along in Cap
#6	75	18'-0"	11.0	Along in Cap
#6	76	18'-0"	11.0	Along in Cap
#6	77	18'-0"	11.0	Along in Cap
#6	78	18'-0"	11.0	Along in Cap
#6	79	18'-0"	11.0	Along in Cap
#6	80	18'-0"	11.0	Along in Cap
#6	81	18'-0"	11.0	Along in Cap
#6	82	18'-0"	11.0	Along in Cap
#6	83	18'-0"	11.0	Along in Cap
#6	84	18'-0"	11.0	Along in Cap
#6	85	18'-0"	11.0	Along in Cap
#6	86	18'-0"	11.0	Along in Cap
#6	87	18'-0"	11.0	Along in Cap
#6	88	18'-0"	11.0	Along in Cap
#6	89	18'-0"	11.0	Along in Cap
#6	90	18'-0"	11.0	Along in Cap
#6	91	18'-0"	11.0	Along in Cap
#6	92	18'-0"	11.0	Along in Cap
#6	93	18'-0"	11.0	Along in Cap
#6	94	18'-0"	11.0	Along in Cap
#6	95	18'-0"	11.0	Along in Cap
#6	96	18'-0"	11.0	Along in Cap
#6	97	18'-0"	11.0	Along in Cap
#6	98	18'-0"	11.0	Along in Cap
#6	99	18'-0"	11.0	Along in Cap
#6	100	18'-0"	11.0	Along in Cap

158

DATE	PROJECT	SHEET
11-20-57	CANEBOAT	16-15

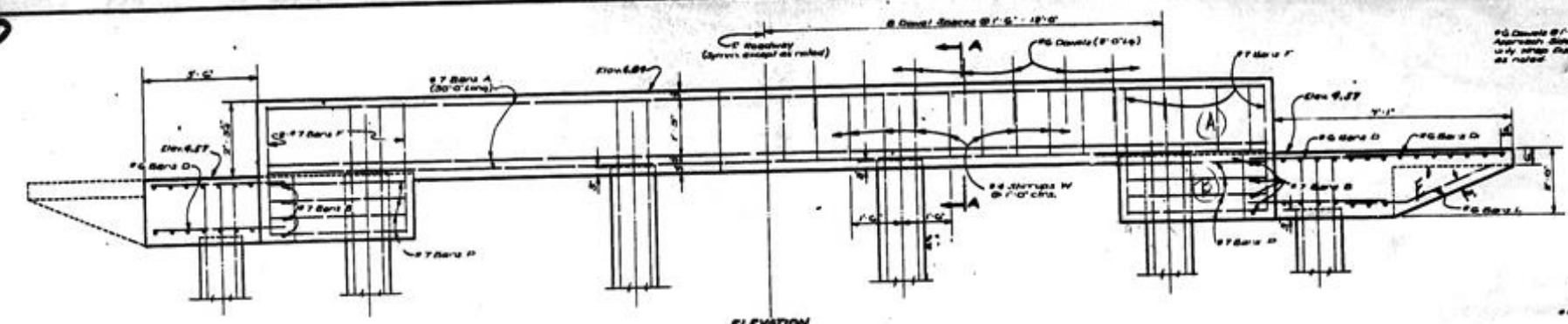

NOTE:

1. PRECAST CONCRETE PILES

2. Concrete Pile in Bent proper to be cut off 2'-0" so that Main and Reinforcing Bars will extend not less than 1'-0" into Cap. Reinforcement will be made for 2'-0" into cap in accordance with the S.D. Specs.

3. Concrete Pile in Platform to be cut off 1'-0" so that Main and Reinforcing Bars will extend not less than 1'-0" into Cap. Reinforcement will be made for 1'-0" into cap in accordance with the S.D. Specs.

AVERAGE PILE LOAD - SEE PAGES PER PILE

P.E. Says: *Drill to bottom*

Pay out after

150

NOTE

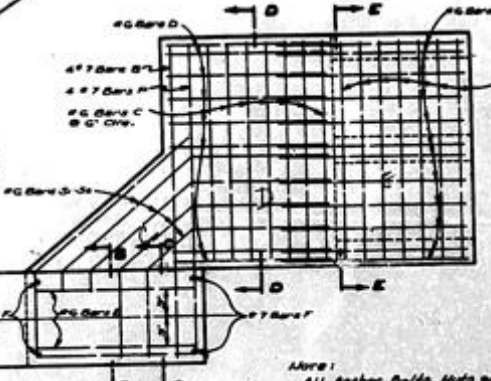
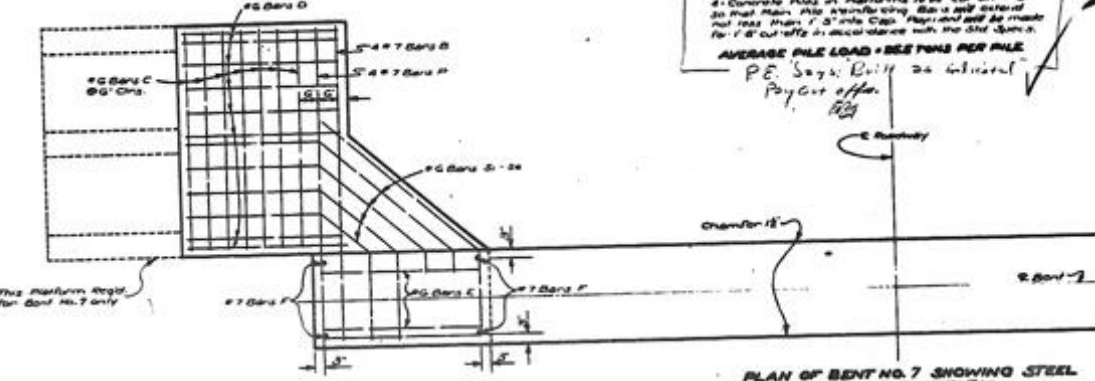

NOTE:

All Anchor Bolts, Nuts and Washers to be Hot-Dipped Galvanized.

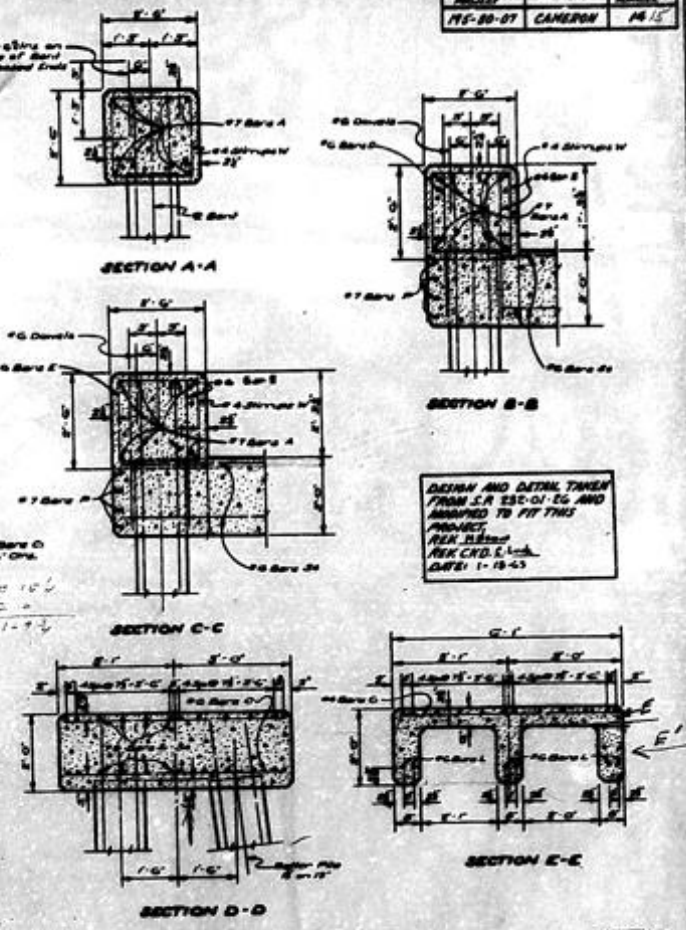

DESIGN AND DETAIL TAKEN FROM S.D. SPEC. 15-1 AND ASSUMED TO FIT THIS PROJECT.

REV. 11-18-53

DATE: 1-18-53

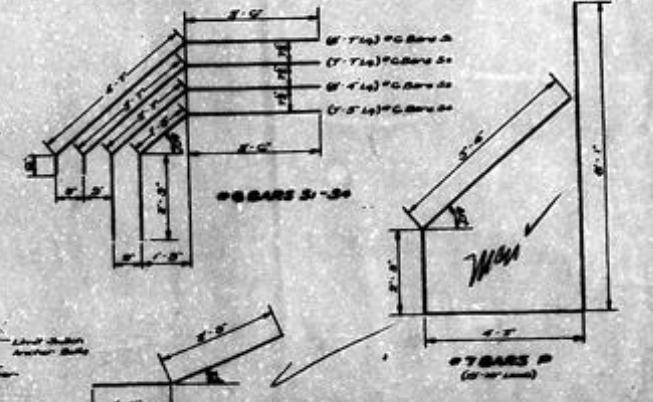
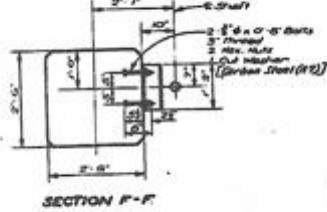
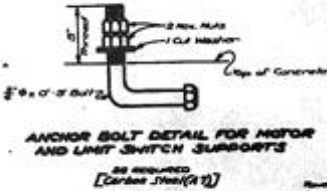
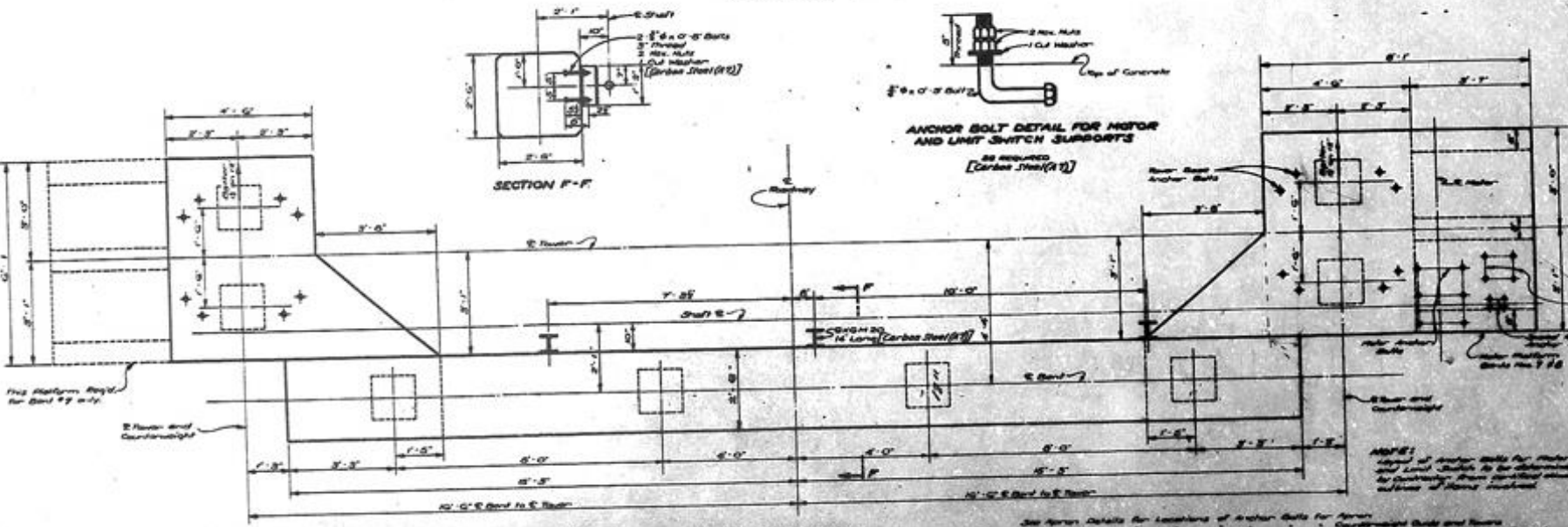

NOTE:

Level of Anchor Bolts for Motor and Limit Switch to be determined by Contractor from finished surface of Bent proper.

PROJECT

SWEET LAKE PONTOON BRIDGE AND APPROACHES

INTRACOSTAL WATERWAY

LS 304

Drawn: D. G. H. C.

STATE OF LOUISIANA

DEPARTMENT OF HIGHWAYS

DESIGNED BY	DRAWN BY	CHECKED BY
APPROVED BY	DATE	

DATE: 1-18-53

SHEET 1 OF 1

REINFORCEMENT PLANS



160

Plan 175-80-01	Part CAMERON	Sheet 1617
-------------------	-----------------	---------------

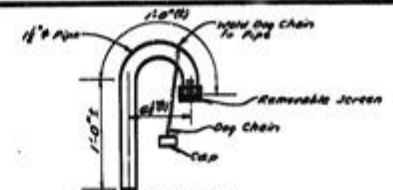

DETAIL B - AIR VENT
 PLACE UNDER JOIST IN EACH COMPARTMENT
 APPROXIMATELY OPPOSITE TO MATCH B. 100'S.
 NOTE: DO NOT EXTEND BEYOND SHOULDER LINE OF BARGE.

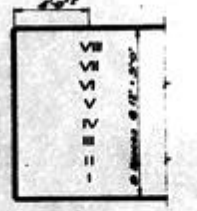
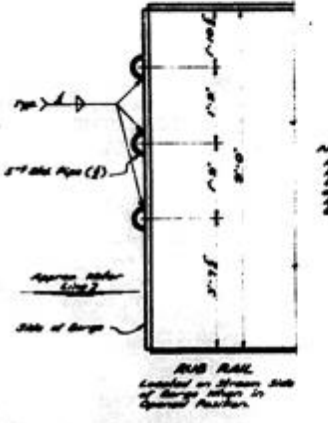
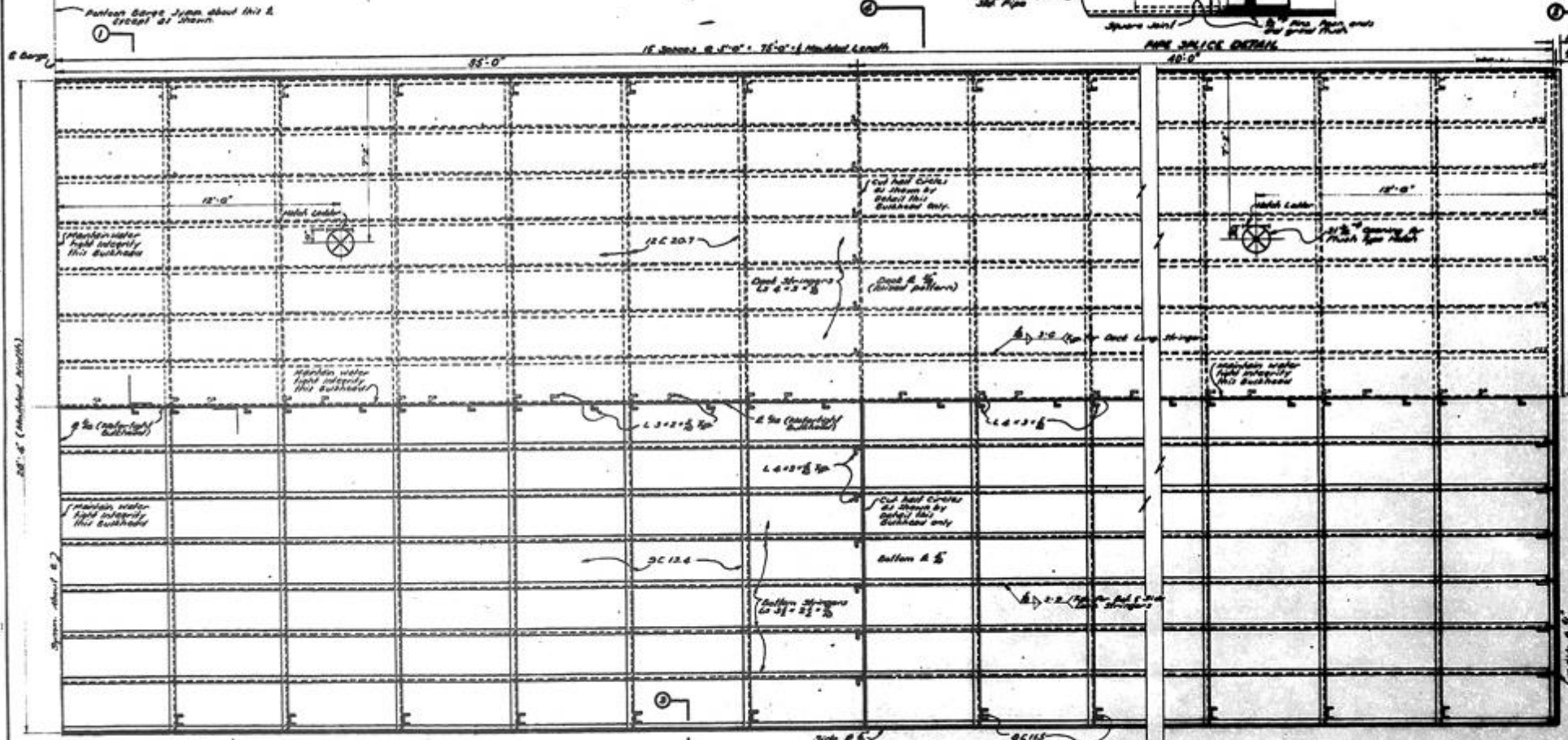
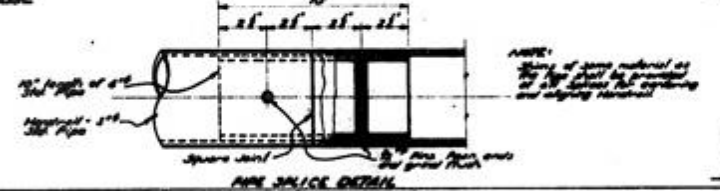
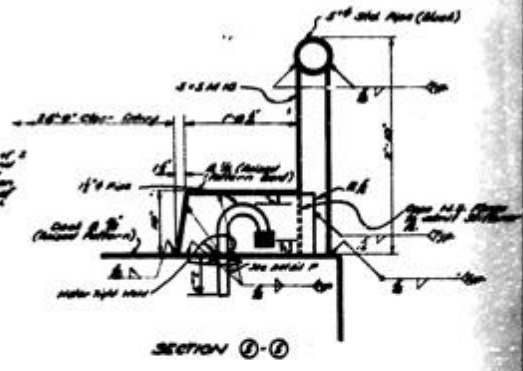
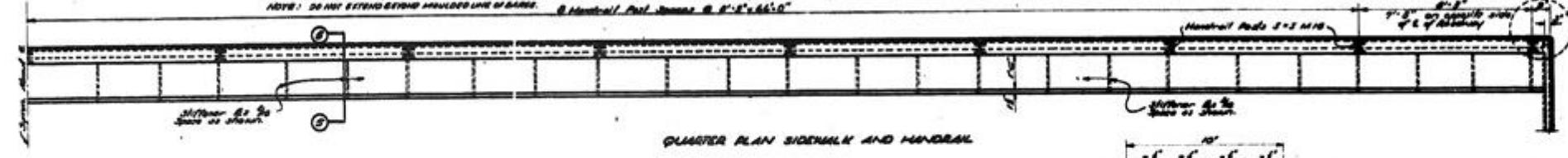
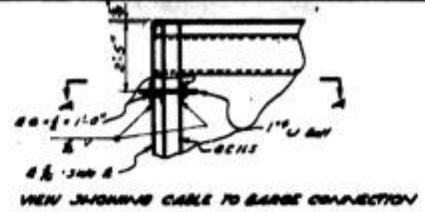
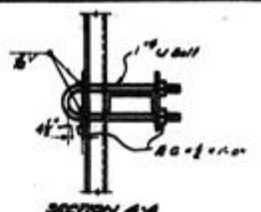

SECTION AND DETAIL TAKEN FROM J.A. 232-01-76 AND APPROVED BY CIVIL ENGINEER. REV. 10/11/52. DRAWN BY J.A. 232-01-76.

NOTE: For structural detail on deck floor, see SHEET 175-80-01.

PONTON SHORE DETAIL

SWEET LAKE PONTON BRIDGE AND APPROACHES
 INTRACOASTAL WATERWAY
 La 384

REVISED PLAN, 6, 1952

STATE OF LOUISIANA
 DEPARTMENT OF HIGHWAYS

DESIGNED BY	ENGINEER	IN CHARGE	DATE
CHECKED BY	REVISIONS	BY	DATE

Robert Lockery



163

DATE	PROJECT	SHEET
DEC 5 '42	LA 384	163

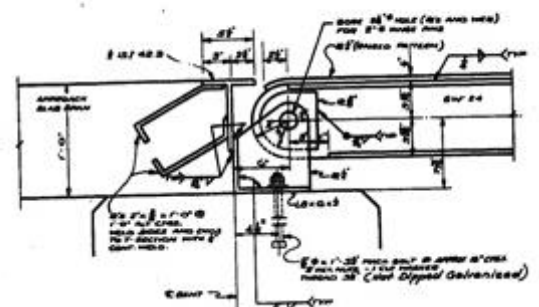
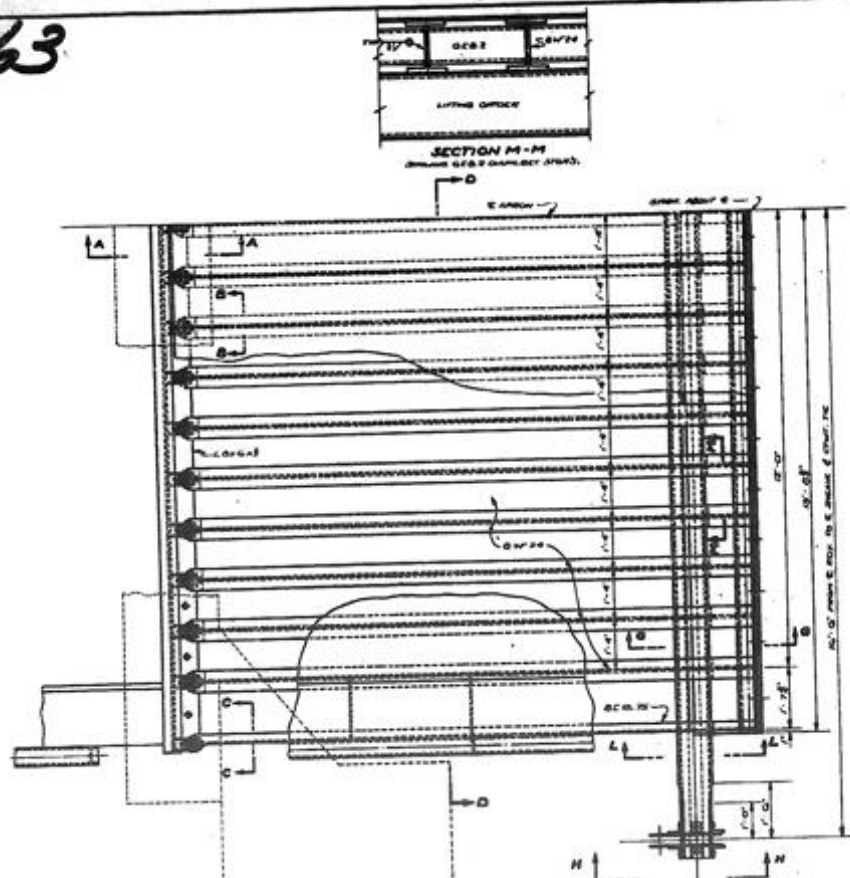

NOTE:
CARBON STEEL (A7) IN END DAMS AND STREAM OF APPROX.
CLEARANCE TO BE PROVIDED WITH APPROX CARBON STEEL (A7).
ALL MAT'L. SHOWN ON THIS SHEET INCLUDING MATERIAL OF
APPROX CLASSIFIED AS CARBON STEEL (A7).

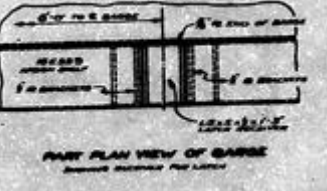
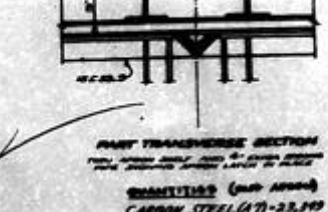
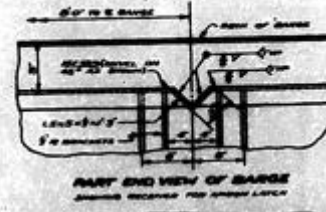
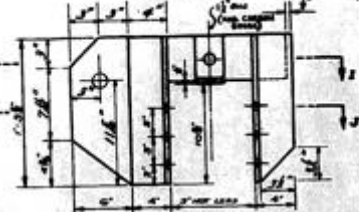
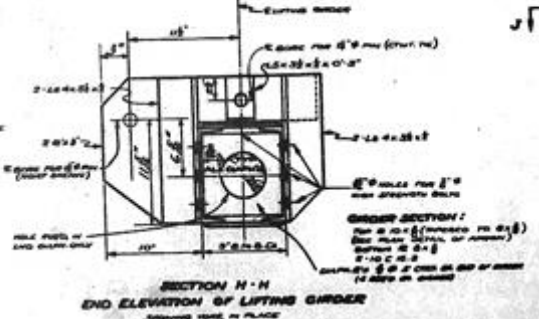
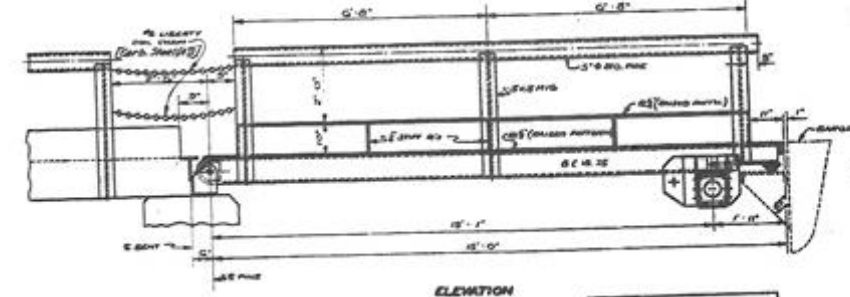
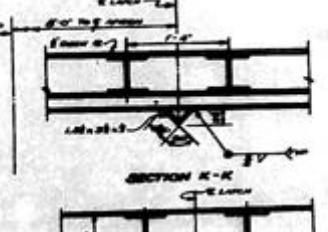
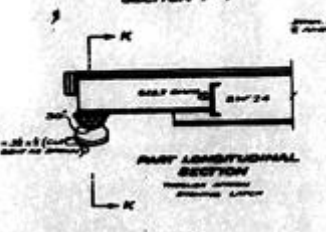
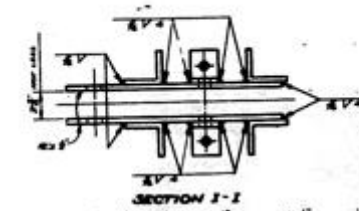
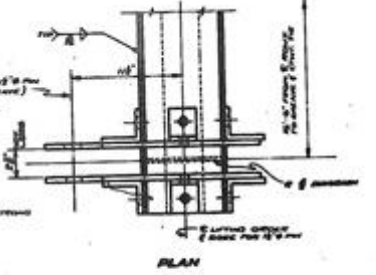
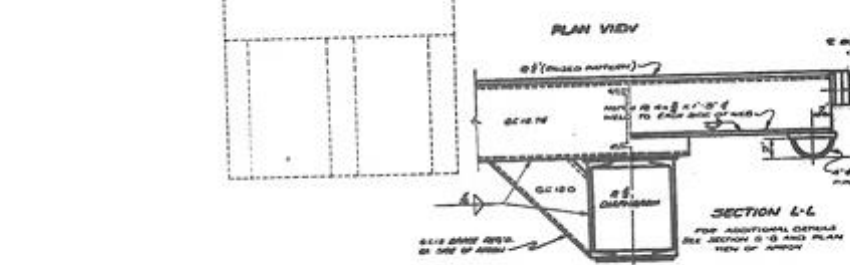
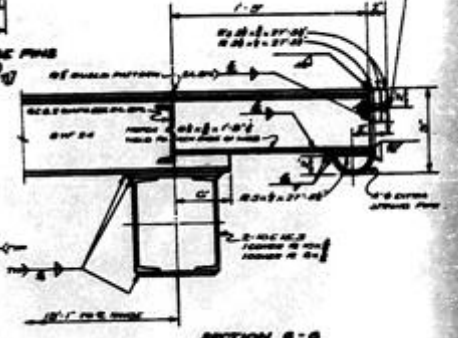
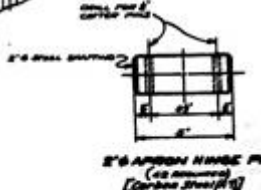
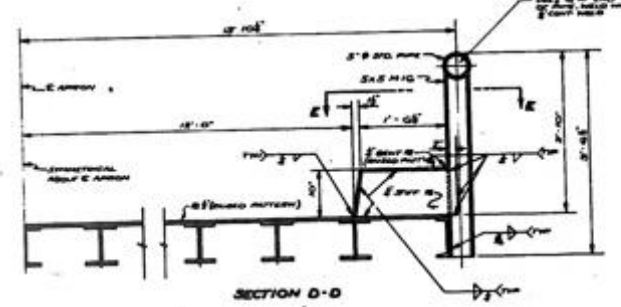
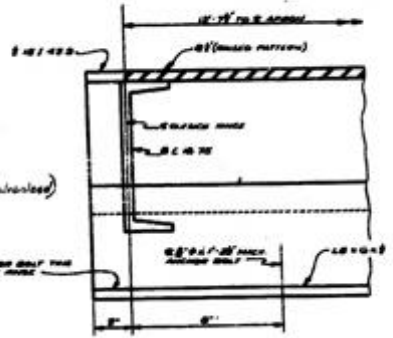
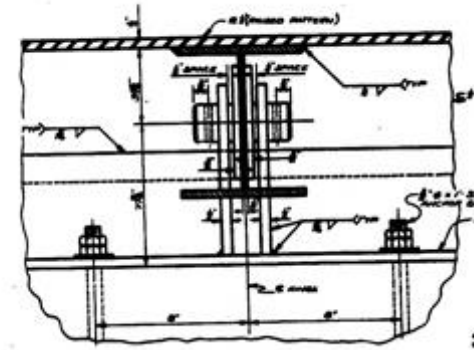

FOR DETAILS
SWEET LAKE PONTOON BRIDGE
AND APPROACHES
INTRACANAL WATERWAY
LA 384
DATE DEC. 5 '42
STATE OF LOUISIANA
DEPARTMENT OF HIGHWAYS

DESIGNED BY	DETAILS BY	TRAINED D. AMBROSIO
CHECKED BY	ENGINEER	FRANK J. GIBSON
APPROVED BY	BRIDGE ENGINEER	

DESIGN AND DETAIL TAKEN
FROM J.P. 225-02-55 AND
MODIFIED TO FIT THIS
PROJECT.
REP. 5/20/42
REP. CHG. 9/1/42
DATE: 12-14-42

Robert Roshery

164

DATE	DESIGN	SCALE
1921	100' OF CAMERON	1/4" = 1'

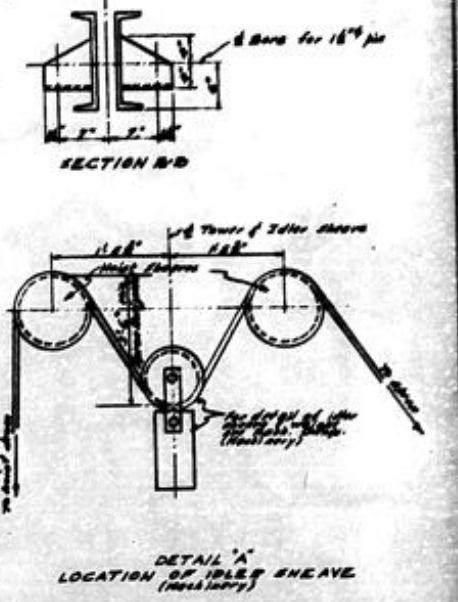
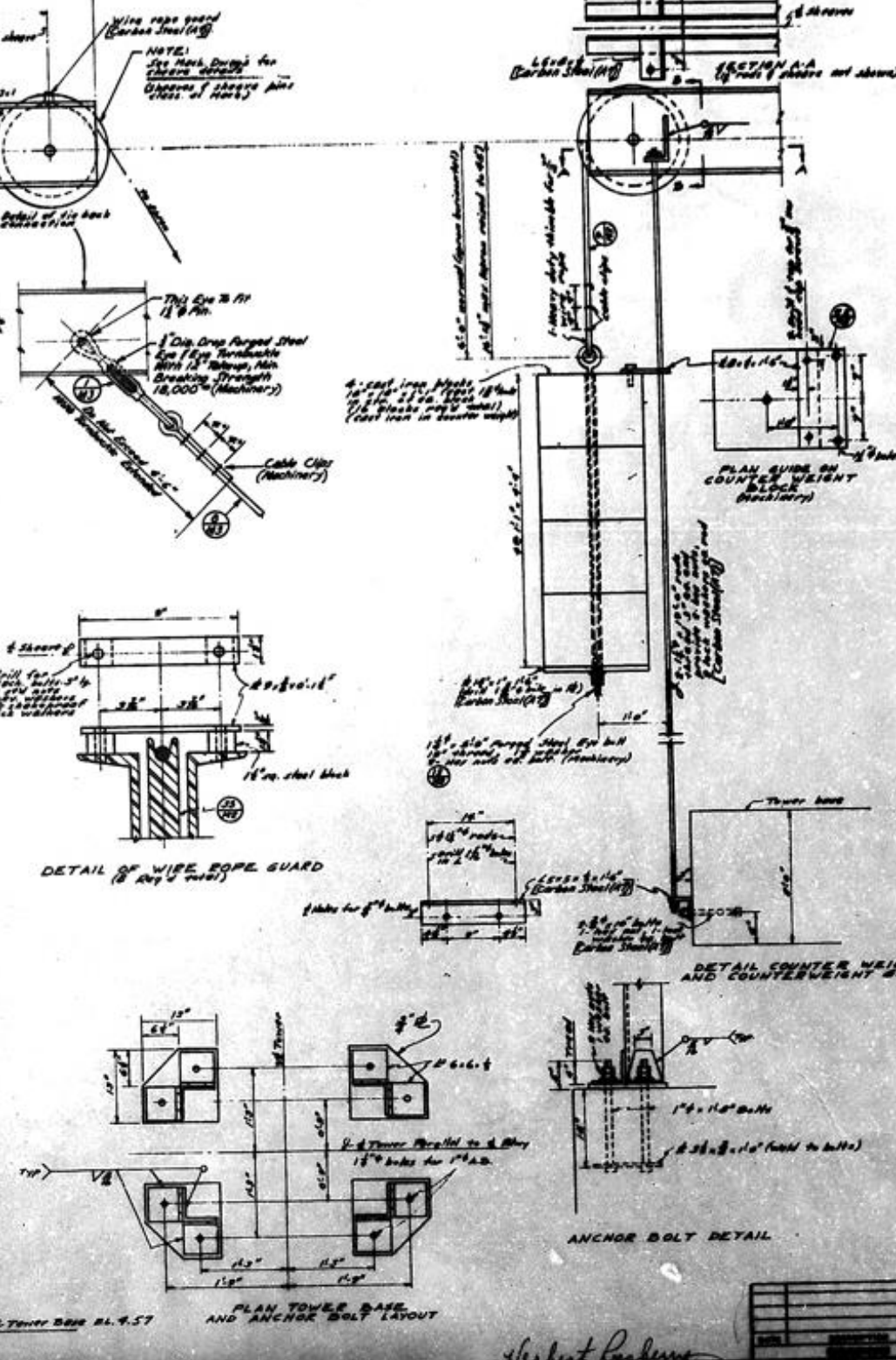
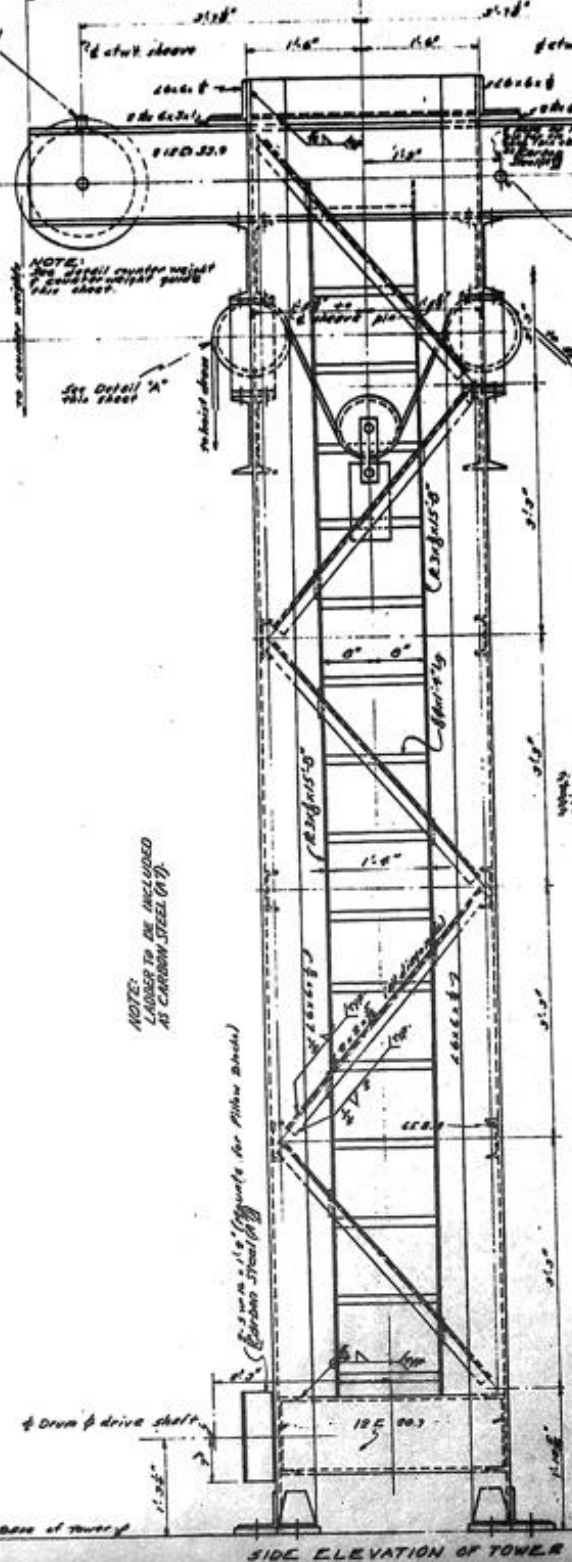
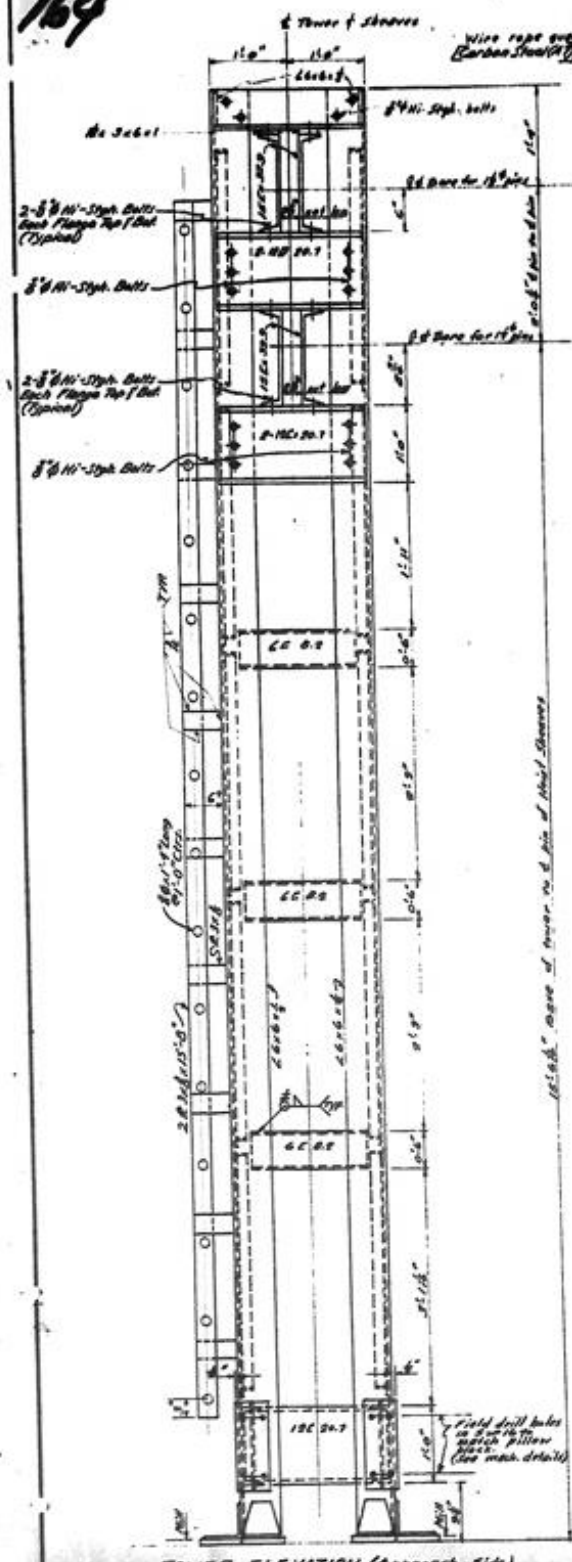

NOTE:
All Anchor Bolts, Nuts and Washers to be Hot-Dipped Galvanized.

DESIGN AND DETAILS TAKEN FROM S.A. 100-10-20 AND APPROVED BY THE PROJECT ENGINEER.
DATE: 12/15/21

QUANTITIES FOR (FOUR) TOWERS
CARBON STEEL (WT) 15352 lbs.
CAST IRON IN COUNTERWEIGHT 17,460 lbs.

NOTE:
ALL ITEMS NOTED 'MACHINERY' TO BE INCLUDED IN ITEM S-B-1, 'MACHINERY BRIDGE MACHINERY'.

TOWER DETAILS

SWEET LAKE PONTOON BRIDGE AND APPROACHES
INTRACOSTAL WATERWAY
L.S. 304

DESIGNED BY: E. W. G. C.

STATE OF LOUISIANA
DEPARTMENT OF HIGHWAYS

DATE: 12/15/21

Robert Lockery

169

STATE PROJECT	PARISH	SHEET NO.
175-80-07	CAMERON	86-24

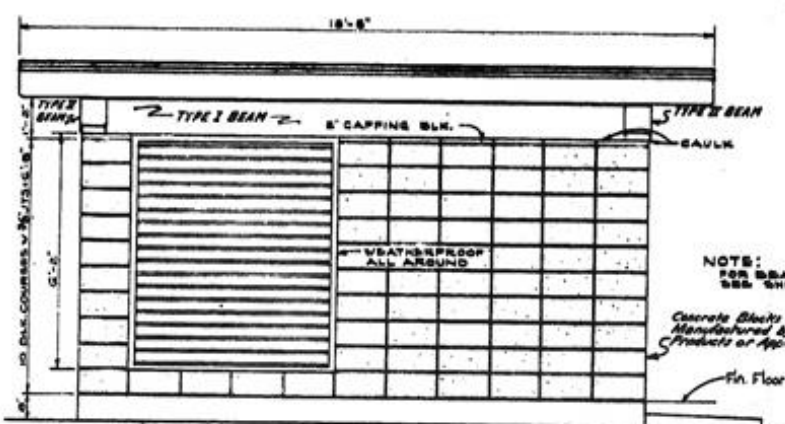

SIDE ELEVATION
SCALE 1/4"=1'-0"

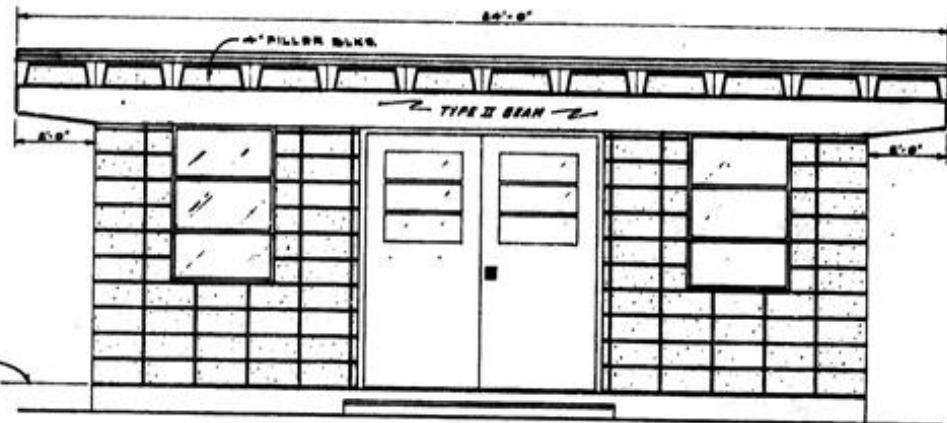

FRONT ELEVATION
SCALE 1/4"=1'-0"

NOTE:
FOR BEAM DETAILS
SEE SHEET 8 OF 8.
Concrete Blocks shall be as
Manufactured by La. Concrete
Products or Approved Equal.
Fin Floor Elev 750

DOOR & WINDOW SCHEDULE		
MARK	SIZE	DESCRIPTION
(A)	6'-0" x 6'-0" x 1'-0"	Heavy Metal Installation Door w/ 200000 Series As Spec'd in General Notes, Frame 5000 Series w/ 2000 Series Hardware. Lockset 1000 Series w/ 2000 Series Key. Finish as Spec'd in General Notes. Glass 1/2\"/>
(I)	2'-0" x 14'-0"	Flux Anneal Window to AIA-2000-G Series 600-A 1/4\"/>

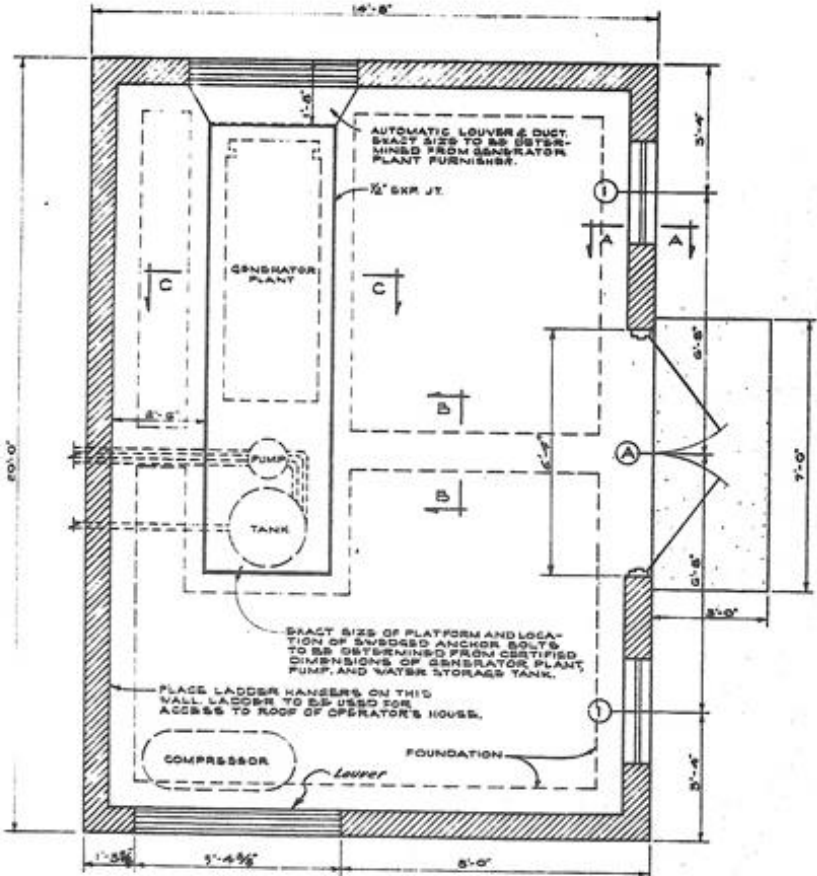

FLOOR PLAN
SCALE 1/4"=1'-0"

NOTE:
Fixed Louvers to be Leak Proof Sheetmetal,
Screened With 1/4" Mesh Aluminum Screen.
Automatic Louver to be Leak Proof Sheetmetal.
All Necessary Anchors and Hardware for Self
Louvers to be Furnished by the Contractor.
All Louvers to be included in price bid for
Machinery House.

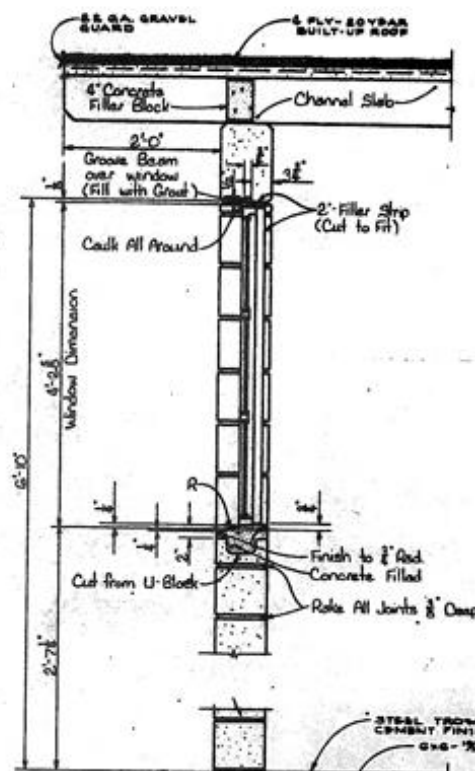

SECTION A-A
SCALE 1/4"=1'-0"

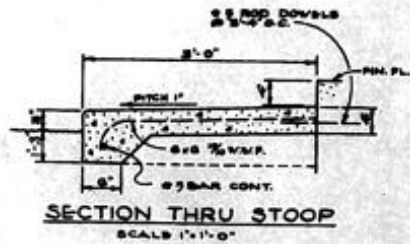

SECTION THRU STOOP
SCALE 1/4"=1'-0"

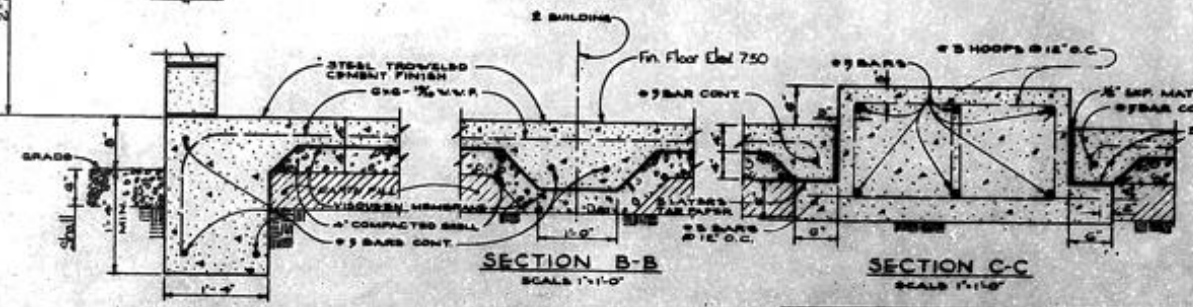

SECTION B-B
SCALE 1/4"=1'-0"

SECTION C-C
SCALE 1/4"=1'-0"

GENERAL NOTES:
CONSTRUCTION SPECIFICATIONS unless approved Local
Code, City, or Parish Ordinance. See A.S.T.M. 1080 for Highway
Gravel, specified in A.A.S.H.O. 100 for Highway
Gravel, specified in 1962, 1964.
REINFORCEMENT BARS shall be intermediate or hard grade
ASTM A615 or A616, A 5 U.S. and Conforming to A.S.T.M. 2002.
Dimensions to finish unless otherwise noted.
All Reinforcement shall be furnished by the Contractor.
Contractor shall furnish the (1) Two-Step Extension
Ladder 16 Foot Long.
Ladder shall be All-Steel-Three-Step Extension Ladder
as Specified by Reinforcement Methods and Co. Ltd. or
Approved Equal and shall be furnished complete with
One Pair Approved Thread Safety Ladder Shoe 1600
Size No.
Cast-in-Place Foundation Concrete to be Class 'A'.
All other Concrete to be as called for in the Special
Provisions.
R - Denotes Class E Rubbed Finish.

DESIGN AND DETAILS TAKEN
FROM S.E. 80-01-05 AND
MOD TO FIT THIS PROJECT
REV. DATE: 10/1/68
DATE: 08/10/1968

MACHINERY HOUSE

SWEET LAKE PONTOON BRIDGE
AND APPROACHES
INTRACOASTAL WATERWAY
La 384

STATE OF LOUISIANA
DEPARTMENT OF HIGHWAYS

DATE: 10/1/68

DESIGNED BY: G. B. G. G. G.

CHECKED BY: G. B. G. G. G.

SCALE: AS SHOWN

SHEET 1 OF 2

Robert Leach



171

DATE PROJECT	PARISH	SHEET NO.
12-20-12	Caddo	27 of 27

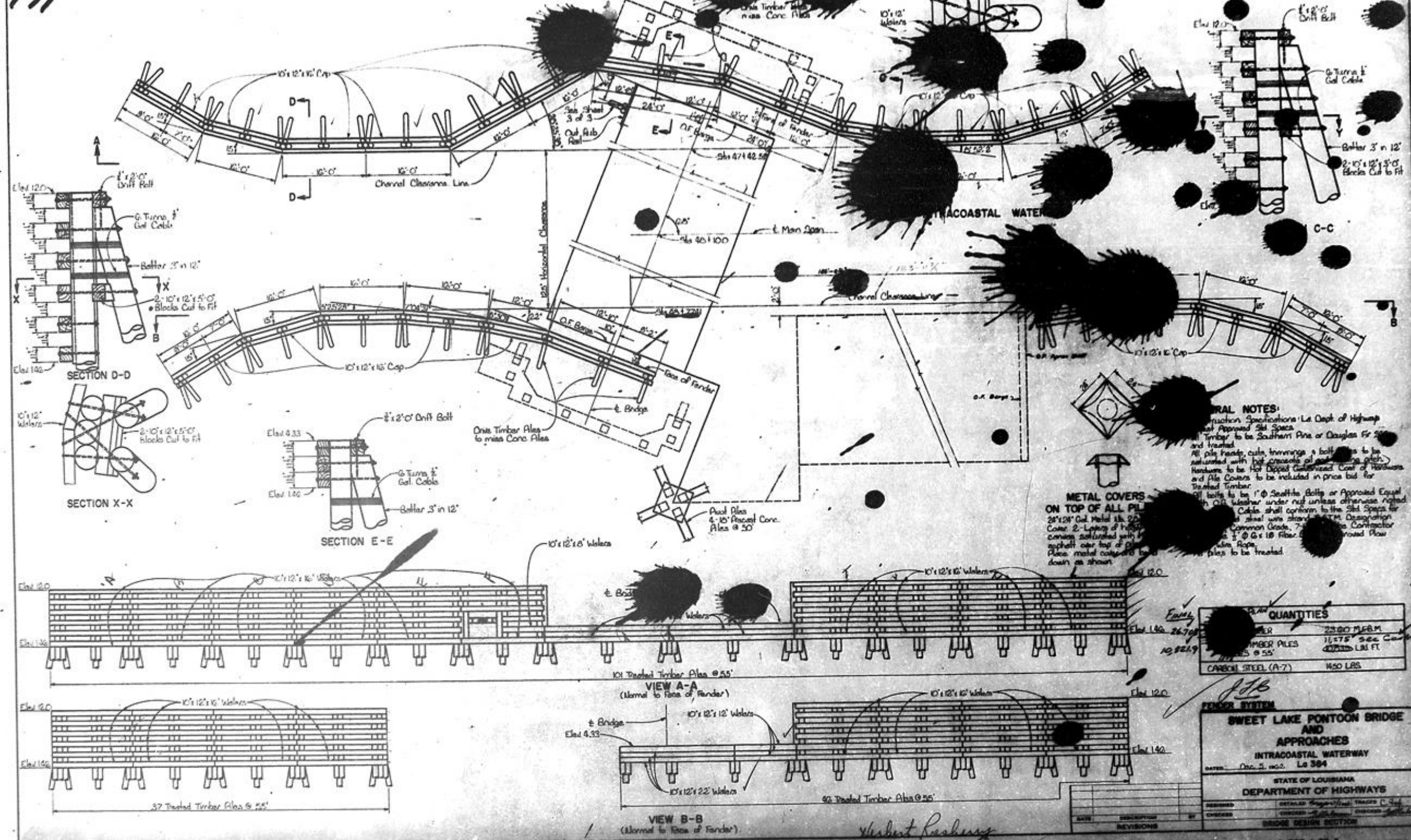

QUANTITIES	
PILE	2300 PLSM
TIMBER PILES	11,575 SCS Carbon
PILES @ 55'	40,330 LBS FT
CARBON STEEL (A-7)	1450 LBS

DESIGNER JTB

PROJECT SWEET LAKE PONTOON BRIDGE AND APPROACHES INTRACOASTAL WATERWAY La 394

DATE Dec. 5, 1912

STATE OF LOUISIANA
DEPARTMENT OF HIGHWAYS

BRIDGE DESIGN SECTION

SHEET 1 OF 3



173

STATE PROJECT	FUND	SHEET NO.
135-30-07	CANARY	80-10

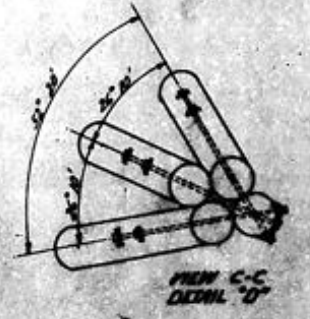
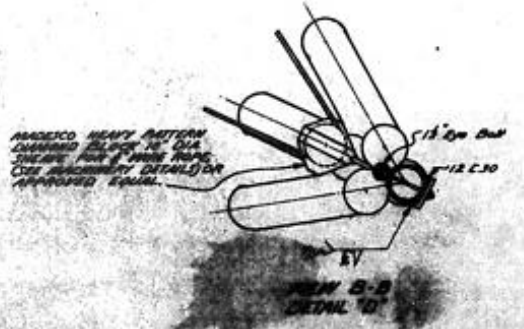
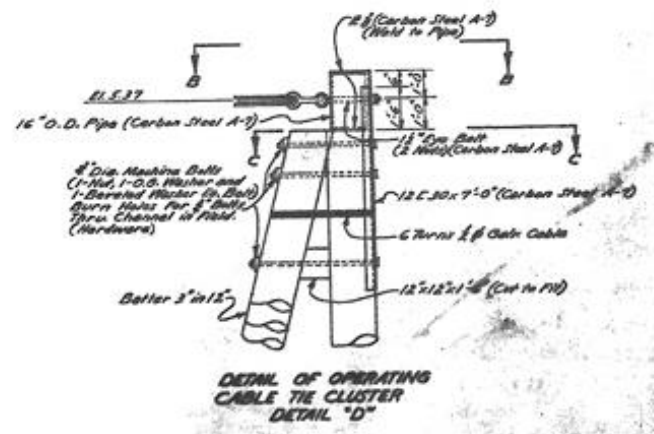
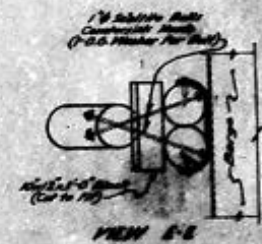
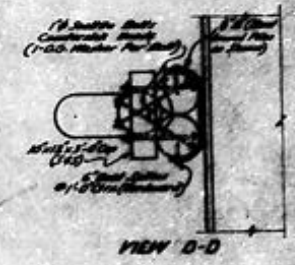
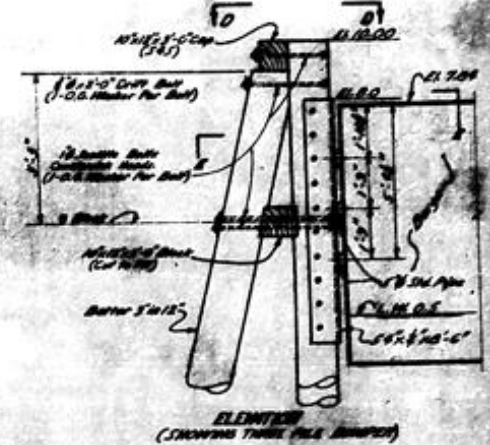
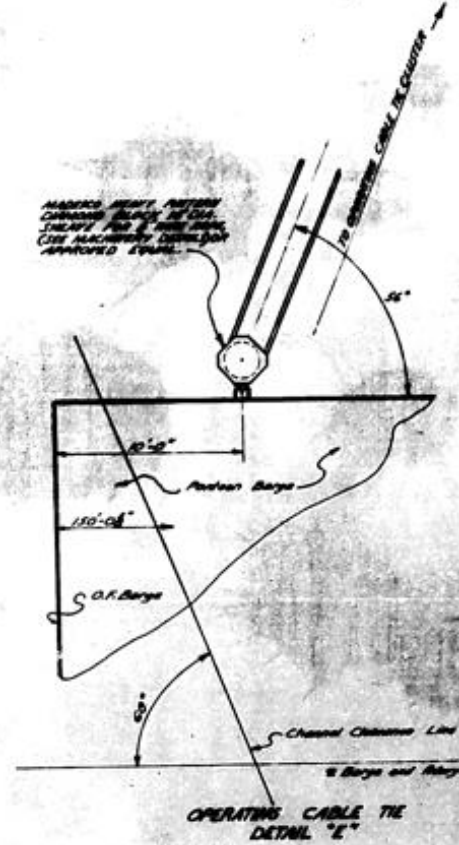
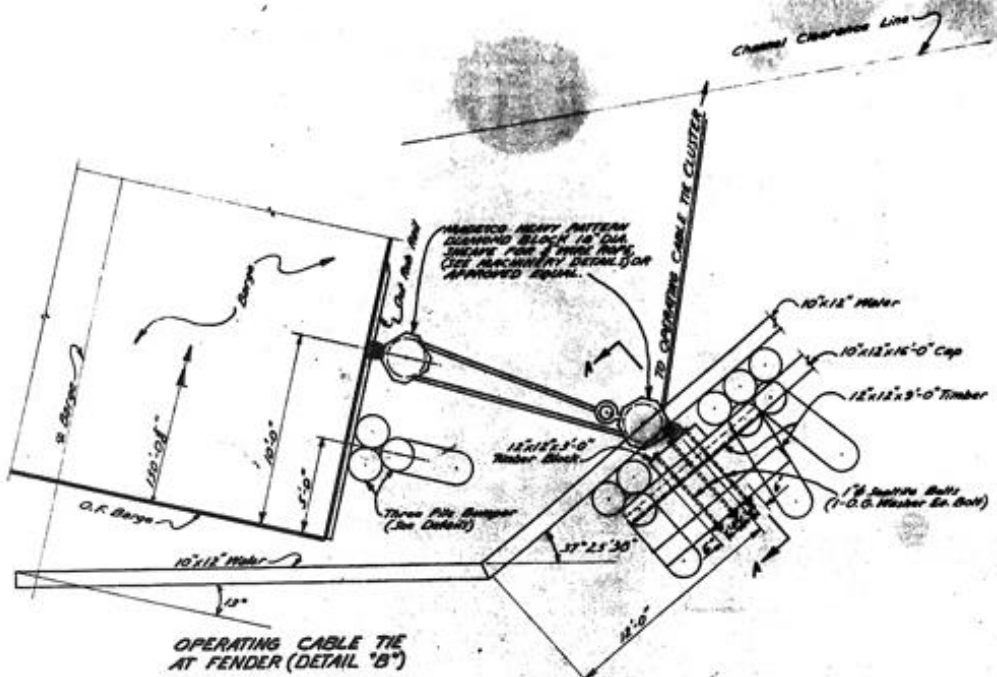
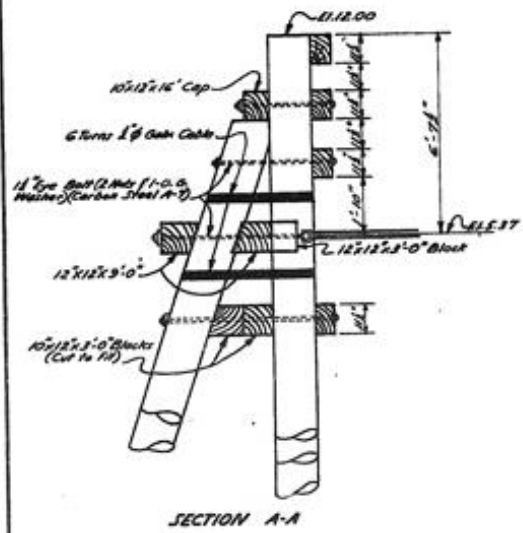

NOTE:
For Calculating One Water File see drawing
to show 1/2 inch diameter
File for 1/2 inch of Pipe (Carbon Steel A-3)

FENDER SYSTEM
SWEET LAKE PORTCOCH BRIDGE
AND APPROXIMATE
STRUCUTURAL SYSTEM
LA 204
DEPARTMENT OF HIGHWAYS

Robert L. ...

125

STATE PROJECT	PARISH	SHEET NO.
181-20-00	CADDOUS	31

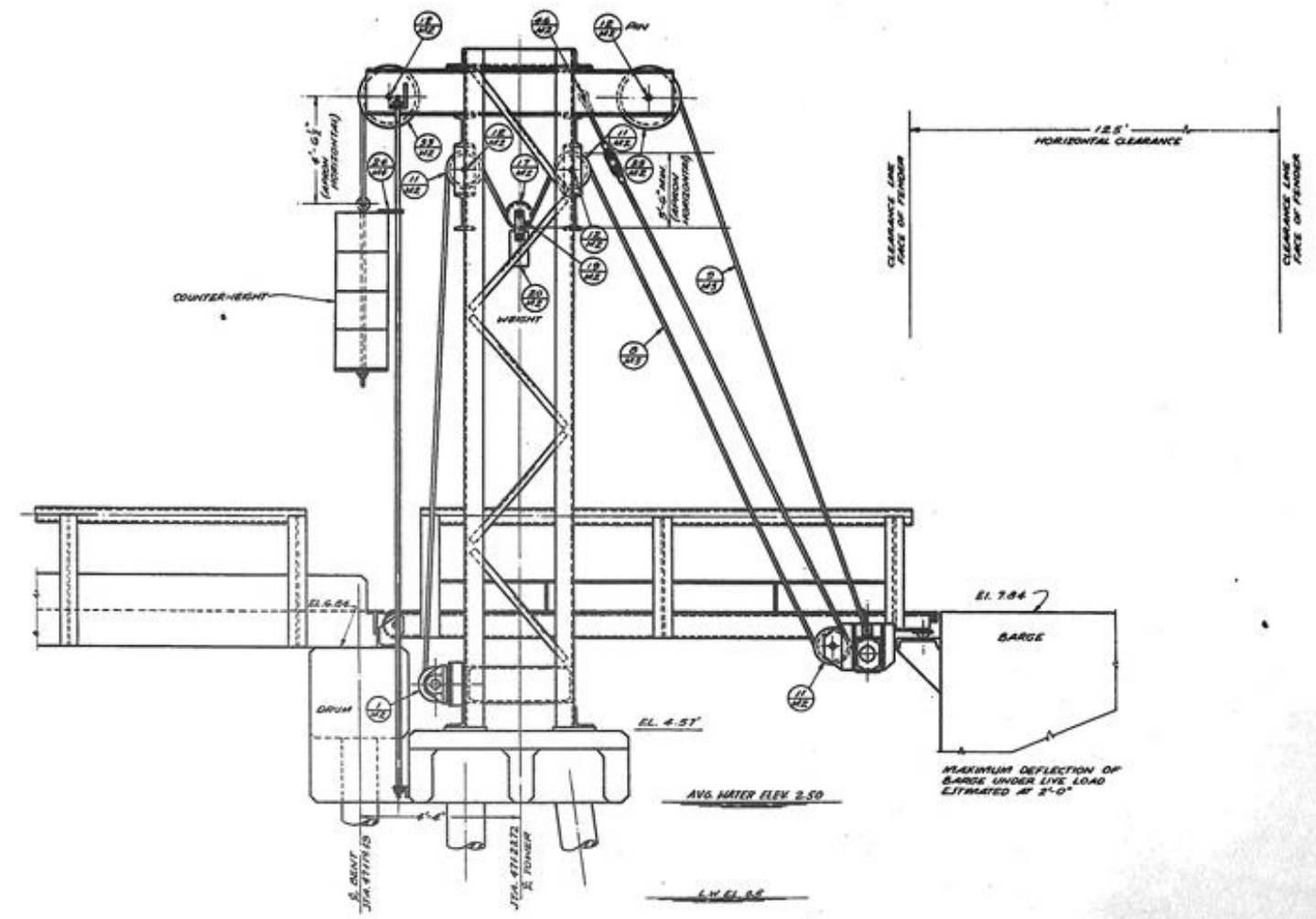

ELEVATION SHOWING APRON DEPRELIED TO A HORIZONTAL POSITION

NOTE:
1/2" CLEARANCE OF ROPE ON DRUM WITH APRON FULLY DEPRELIED.

PART OUTSIDE ELEVATION SHOWING TOWER ASSEMBLY

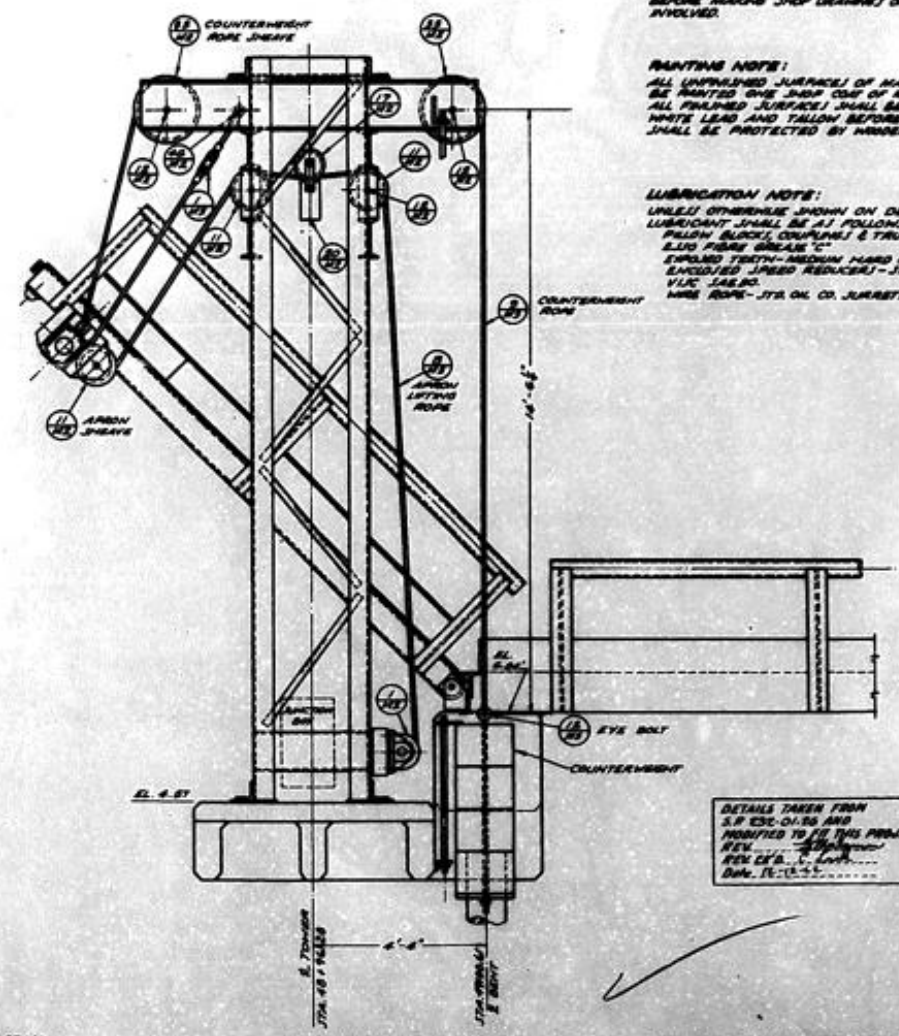

ELEVATION SHOWING APRON RAISED TO 45° POSITION (APRON TO BE RAISED TO 60° POSITION)

NOTE:
THE CONTRACTOR SHALL DETERMINE THE FINAL DIMENSIONS OF PARTS INVOLVING COMMERCIAL PRODUCTS SUCH AS MOTORS, UNITED REDUCERS, GEARBOXES, ELECTRICAL EQUIPMENT AND THE LIKE, FROM CERTIFIED DIMENSIONAL OUTLINE OF THE COMMERCIAL PRODUCTS BEFORE MAKING SHOP DRAWINGS OF THE PARTS INVOLVED.

PAINTING NOTE:
ALL UNFINISHED SURFACES OF MACHINERY SHALL BE PAINTED ONE COAT OF RED LEAD AND OIL. ALL FINISHED SURFACES SHALL BE COATED WITH WHITE LEAD AND TALLOW BEFORE SHIPMENT AND SHALL BE PROTECTED BY WAXEN LAMEN.

LUBRICATION NOTE:
UNLESS OTHERWISE SHOWN ON DETAIL DRAWINGS LUBRICANT SHALL BE AS FOLLOWS OR APPROVED EQUAL: PULLEY BLOCKS, COUPLERS & TRUNKION BEARINGS - SAE 30 OIL GRADE "C" EXPLODED TIGHT-MEDIUM HARD GREASE, ENCLOSED (USED REDUCER) - JTA OIL "TRILLON 65" V.I.C. 100.0. WIRE ROPE - JTA OIL CO. JUMARITTE COMPOUND NY 1500.

DETAILS TAKEN FROM 3-D 230-01-50 AND MODIFIED TO FIT THIS PROJ. REV. BY: L. L. L. Date: 10-1-51

TOWER SHEAVE ARRANGEMENT

SWEET LAKE PONTOON BRIDGE AND APPROACHES
INTRACASTAL WATERWAY
Ls 384

DATED: May 2, 1946

STATE OF LOUISIANA
DEPARTMENT OF HIGHWAYS

DESIGNED	DETAILS	TRACED
CHECKED	CHECKED	ENGINEER

BRIDGE DESIGN SECTION

Robert Cochran

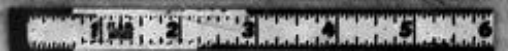

190

STATE PROJECT	PARISH	SHEET NO.
198-30-07	CADDOUA	49

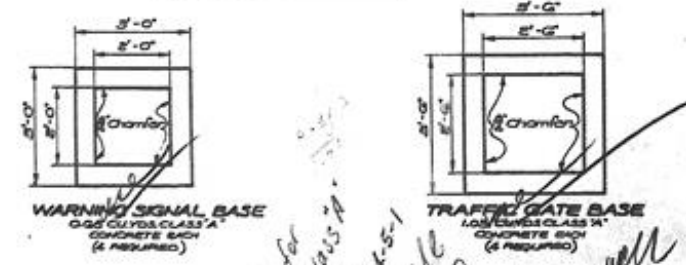
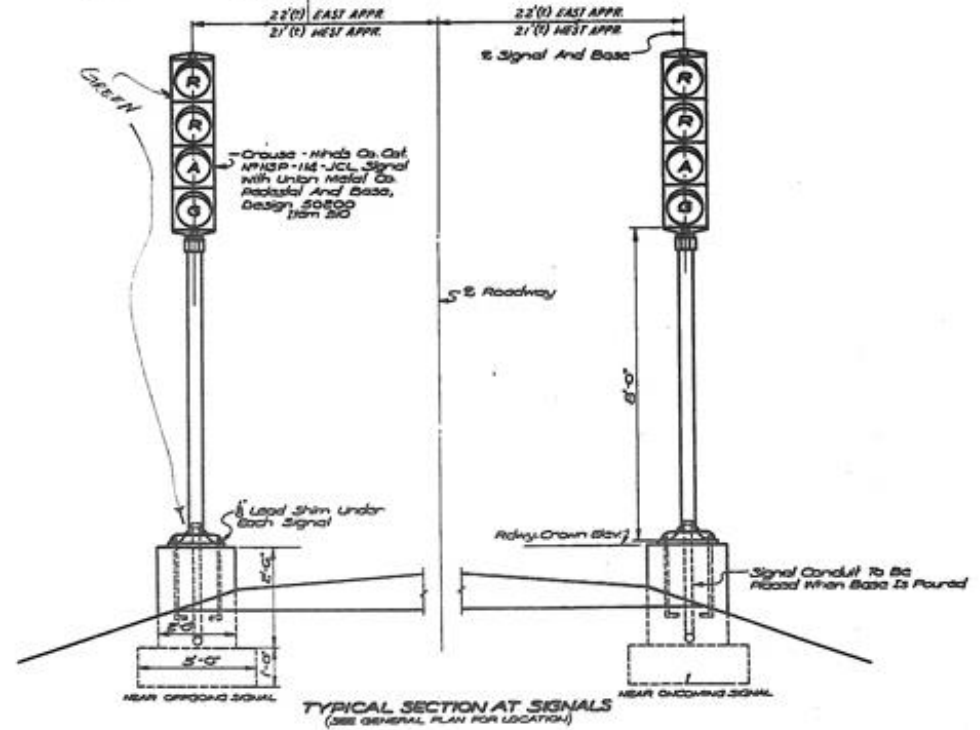
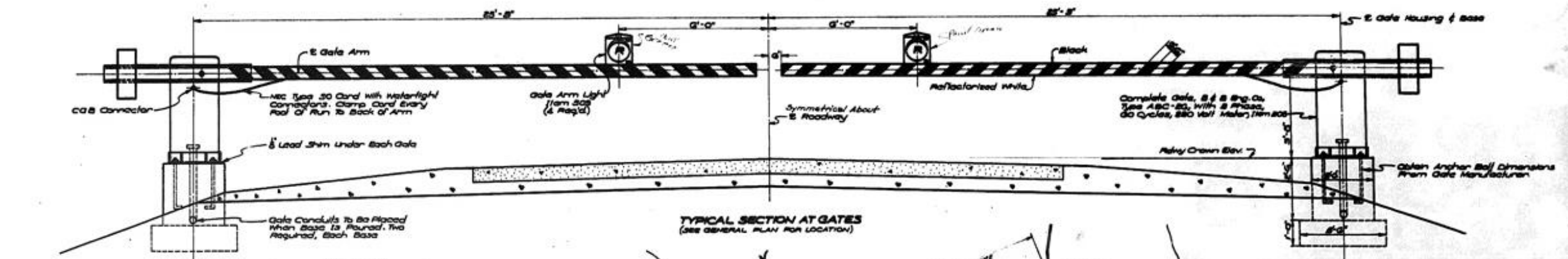

Pay for 25 Class "A" concrete from K-5-1
 J.P.C.
 J.P.C.

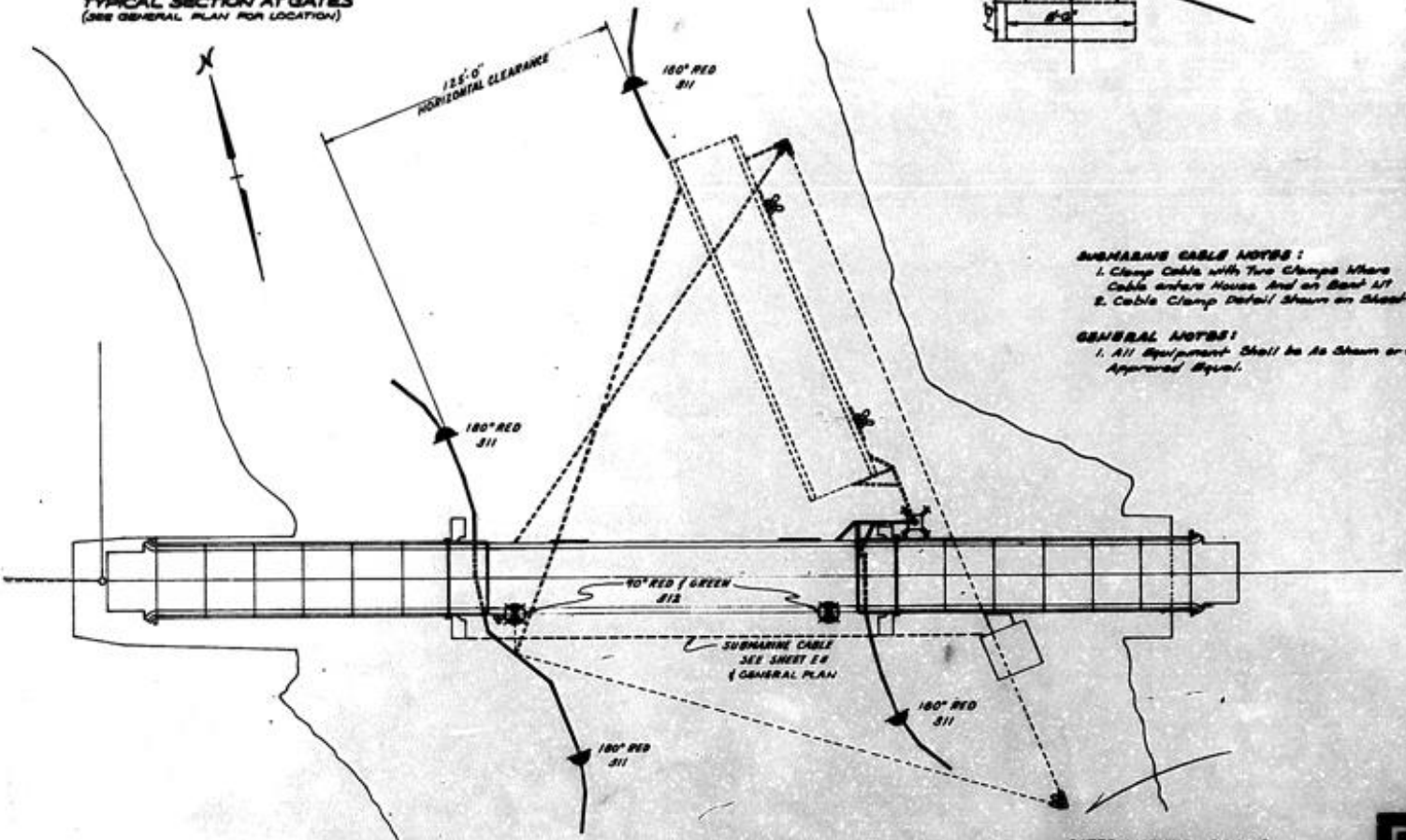

- SUBMERSIBLE CABLE NOTES:**
1. Clamp Cable with Two Clamps Where Cable Enters House and on Base of
 2. Cable Clamp Detail Shown on Sheet E-8.
- GENERAL NOTES:**
1. All Equipment Shall be As Shown or Its Approved Equal.

E8

GATES, WARNING SIGNALS, NAVIGATION LIGHTS

SWEET LAKE PONTOON BRIDGE AND APPROACHES
 INTRACASTAL WATERWAY
 LG 384

DATE: DEC. 2, 1962

STATE OF LOUISIANA
 DEPARTMENT OF HIGHWAYS

DESIGNED BY	TRACER D. ANDREWS
CHECKED BY	CHARLES H. HARRIS
APPROVED BY	WALTER D. ANDREWS

ENGINE DESIGN SECTION

SEE SHEET PLANS



THIS PAGE INTENTIONALLY LEFT BLANK